

ASSEMBLY INSTRUCTION

1600*1900

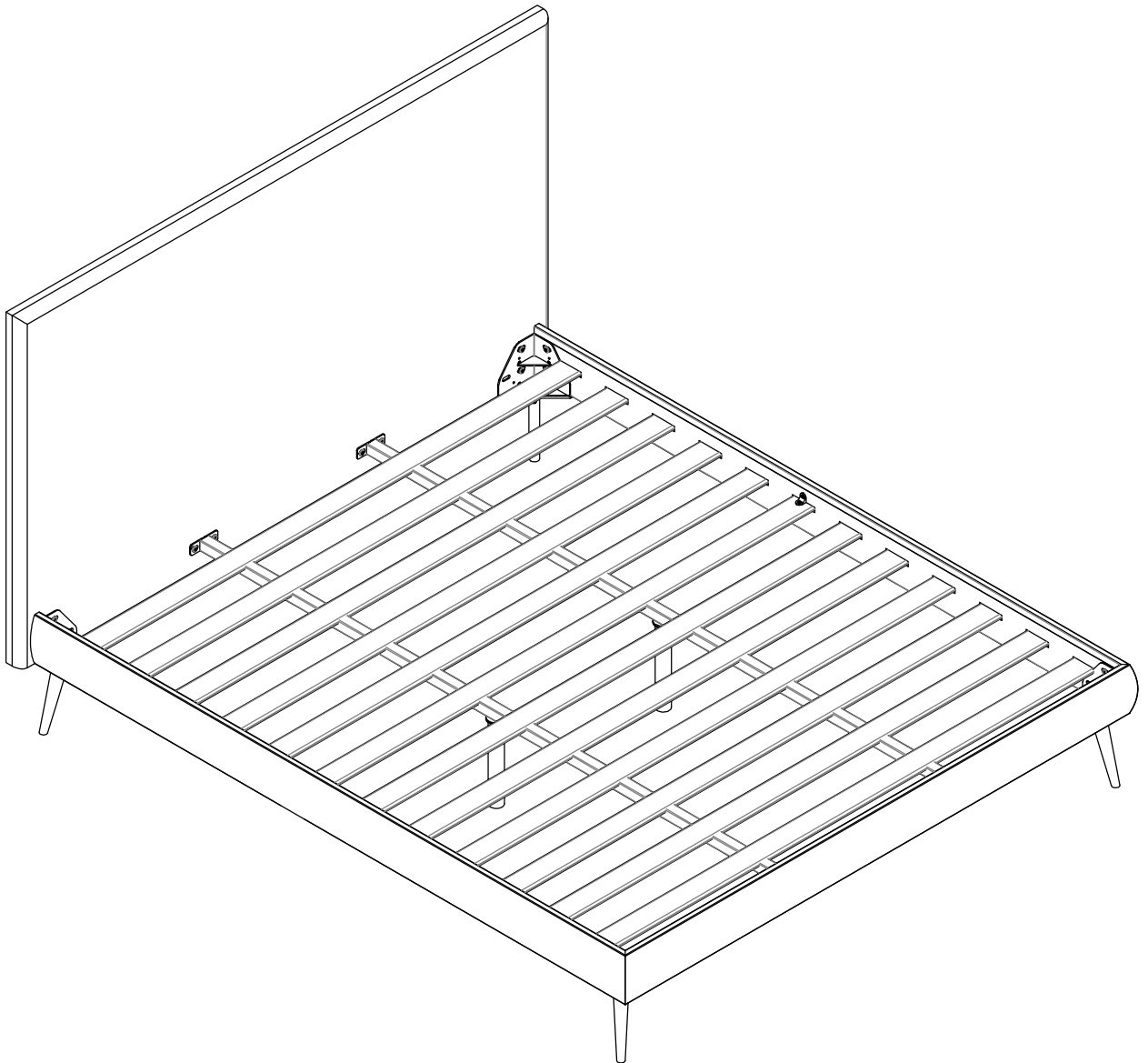

Read this instruction carefully. See hardware and furniture part list for guidance. Be sure all parts are complete before you assemble. Place all wooden furniture parts on a clean and flat soft surface to prevent from being scratched.





Follow the figure to start assembling.

CAUTIONS: 1. Do not FUIYI- TIGHTEN the nut or nut bolt until all nut or bolt is ready assembled.

2. Do not OVER - TIGHTEN the nut or bolt to avoid causing damages to the thread

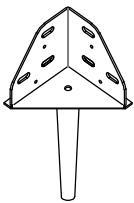
3. Keep all hardware parts out of reach of children.

NOTE :THE LIST AND QUANTITY SHOWN ARE FOR 1 UNIT ASSEMBLY

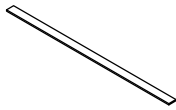
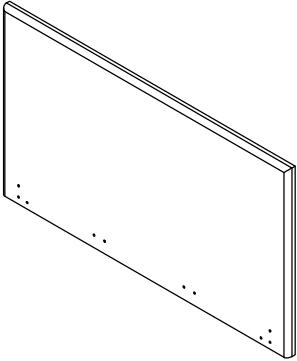
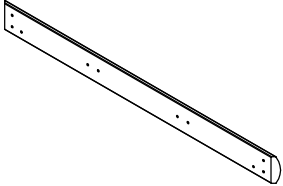
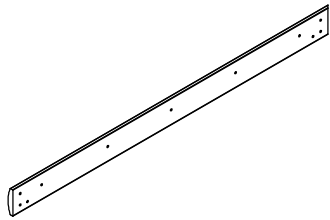
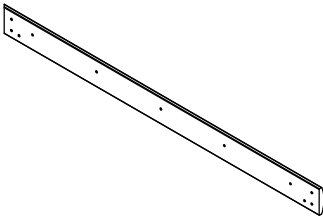
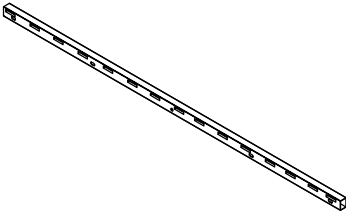
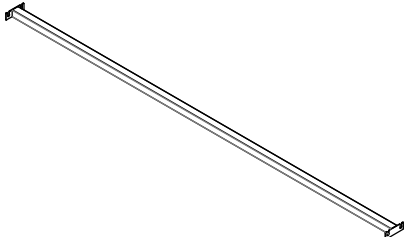
<p>A *4</p> 	<p>B *2</p> 	<p>C *16</p>  <p>M4*20</p>	<p>D *32</p>  <p>M8*20</p>	<p>E *10</p>  <p>M8*45</p>	<p>F *15</p> 	
 <p>① *1</p>		 <p>② *2</p>		 <p>③ *1</p>		
 <p>④ *1</p>		 <p>⑤ *2</p>		 <p>⑥ *2</p>		

1

D		*6
A		*2

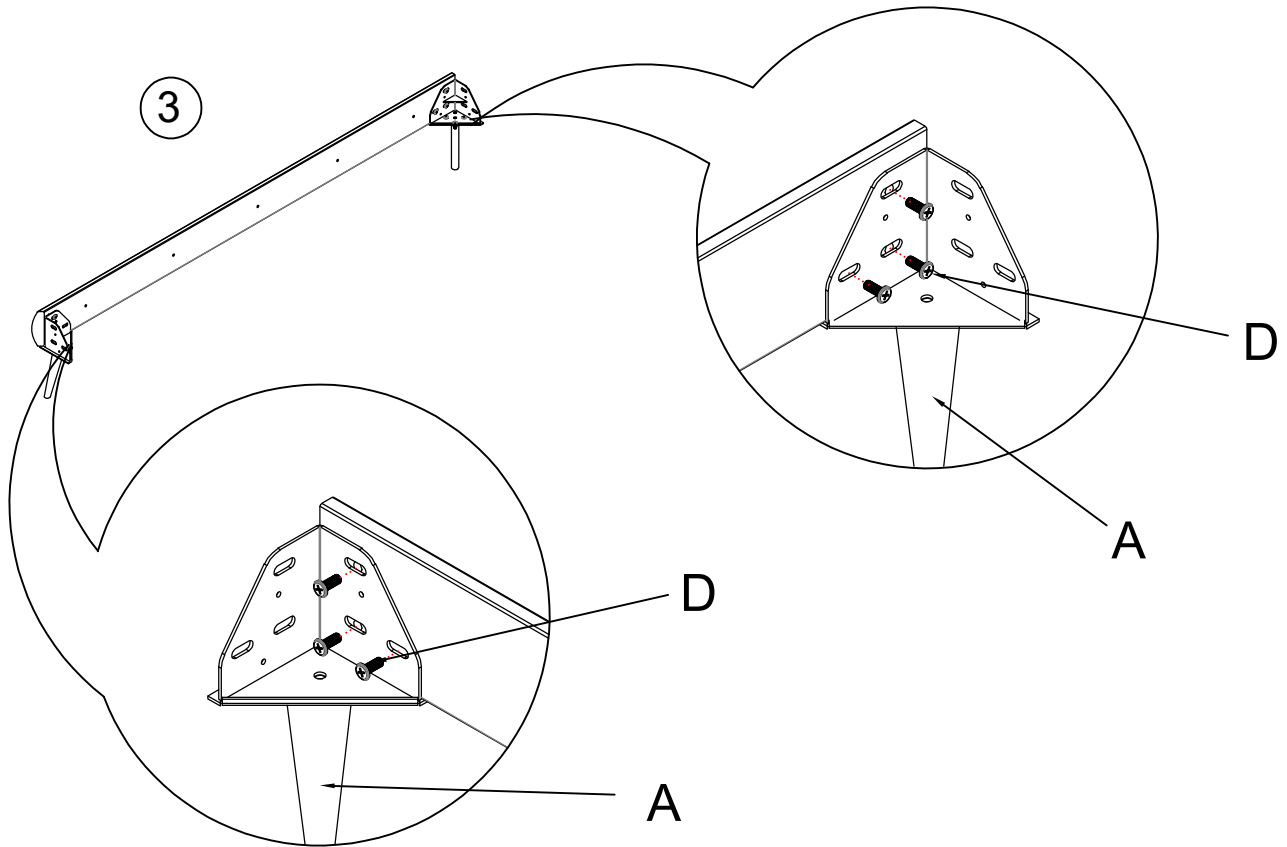

2

D		*6
A		*2

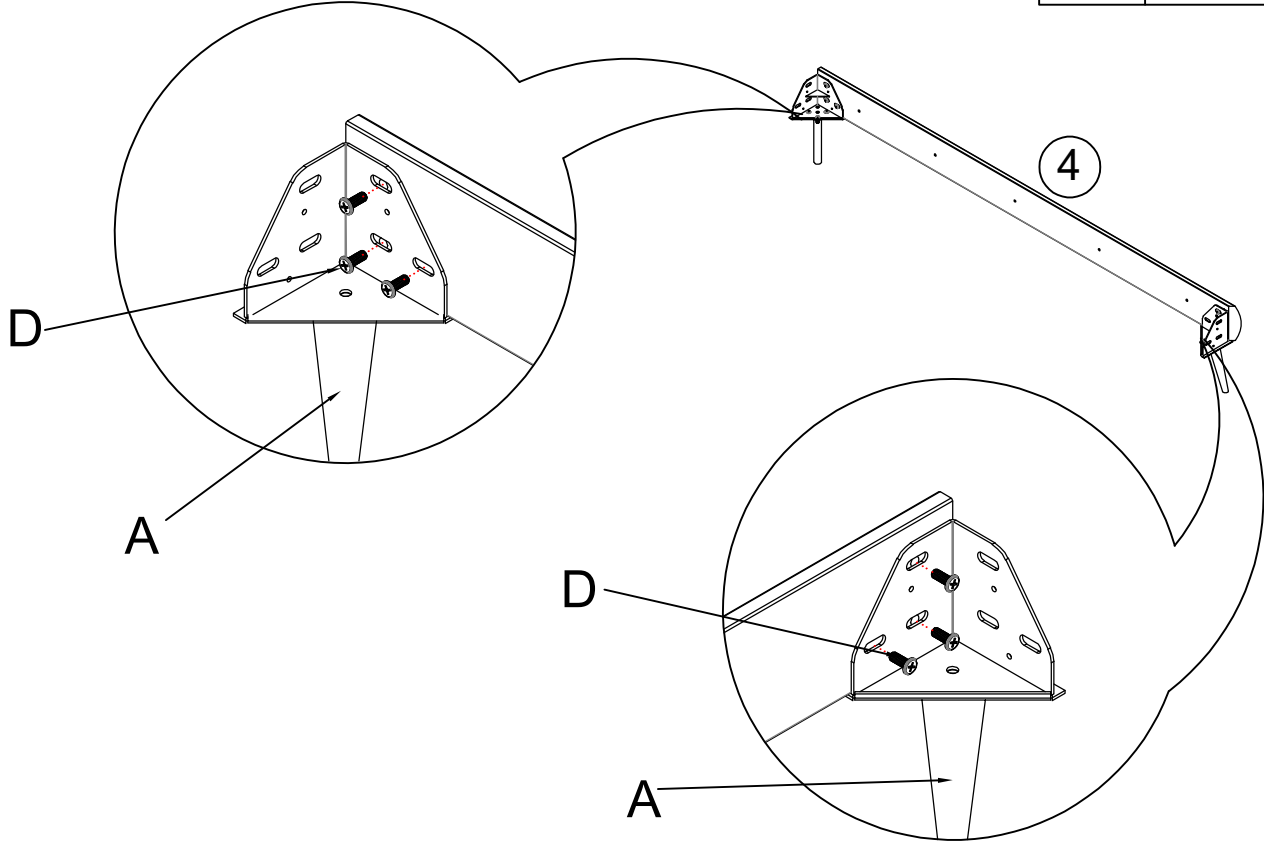

3

D



*6

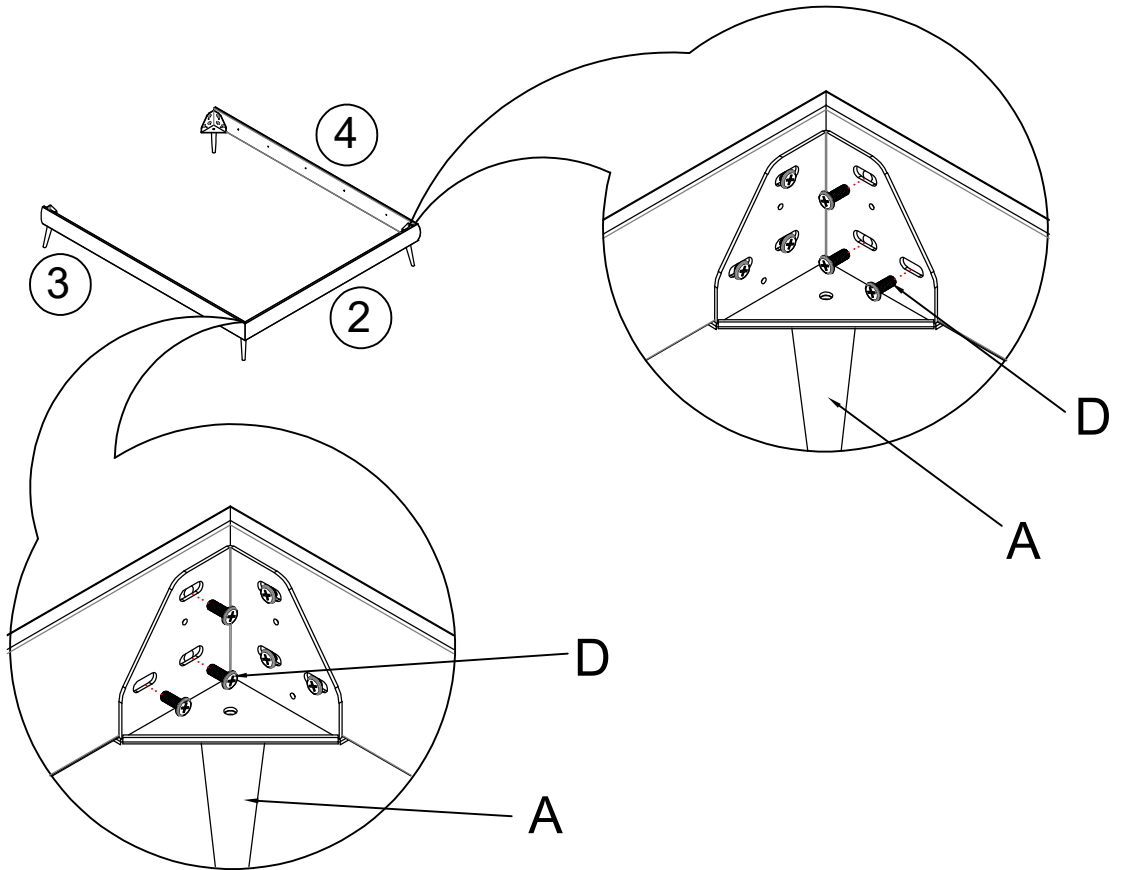

4

D



*6

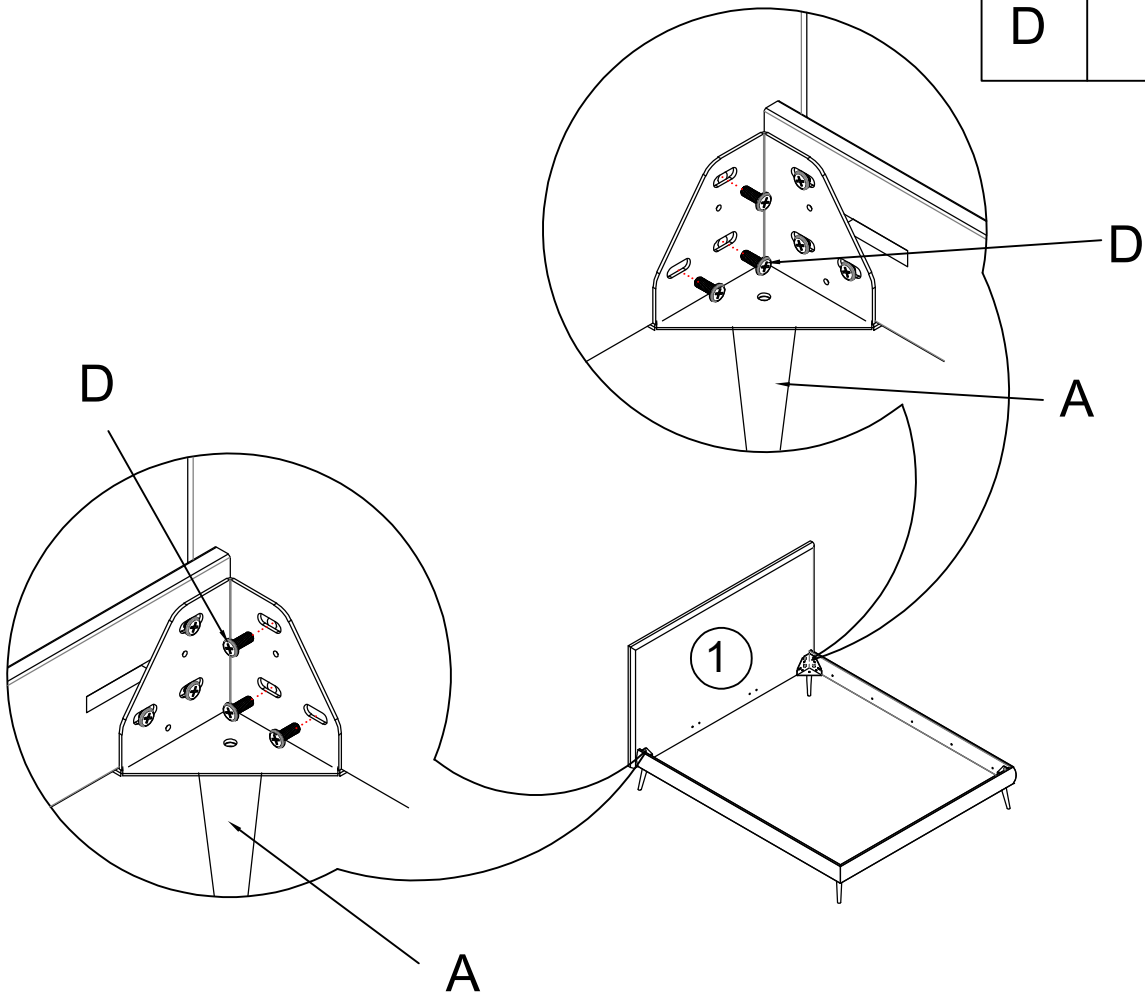

5

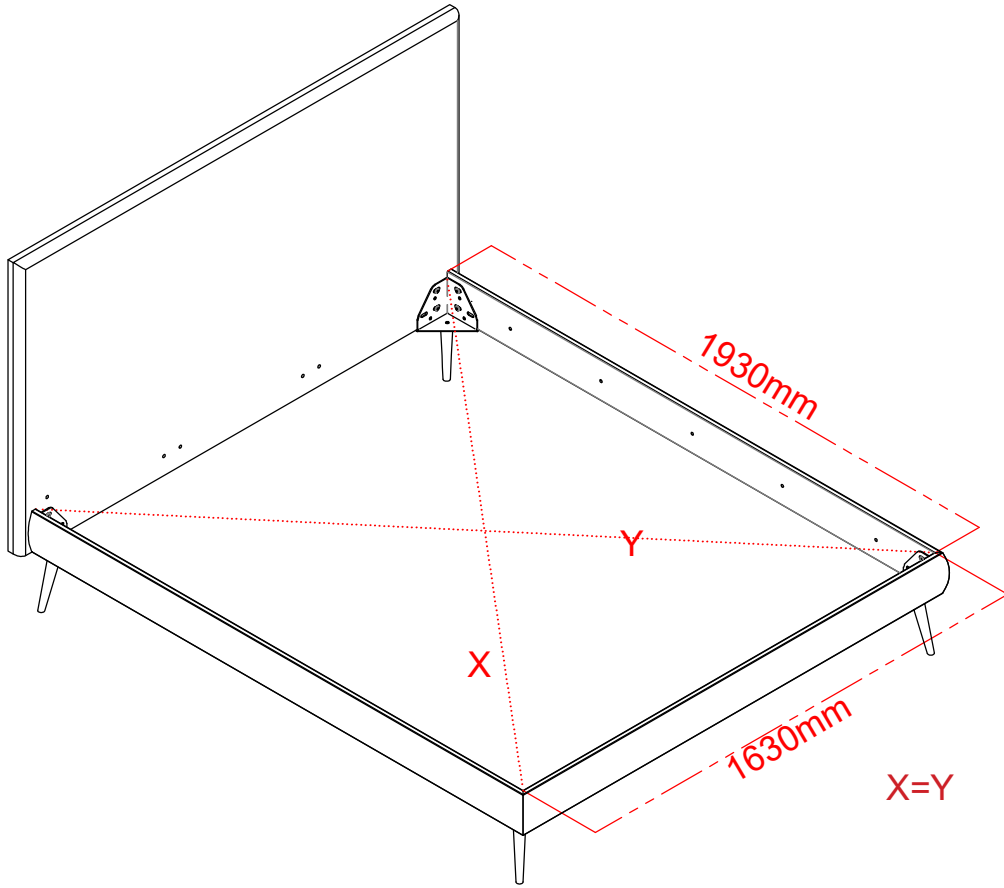

6

C		*16
---	---	-----

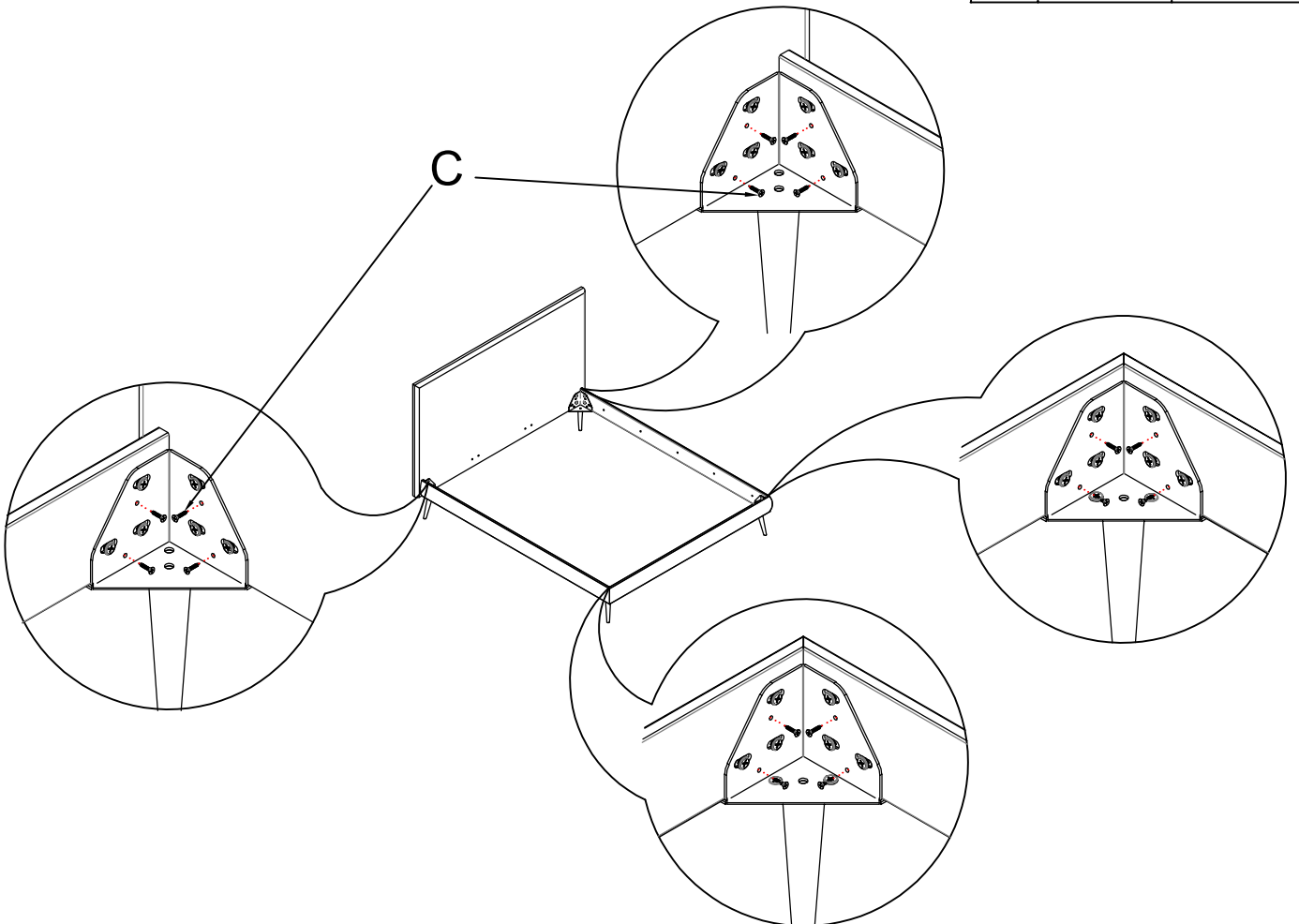

7

E



*10

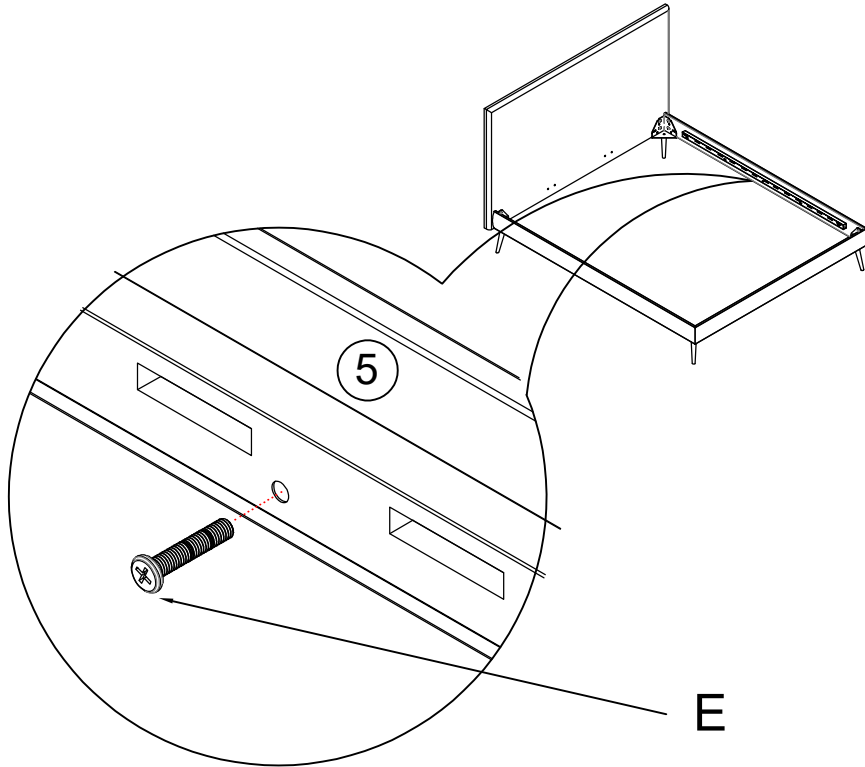

8

D



*8

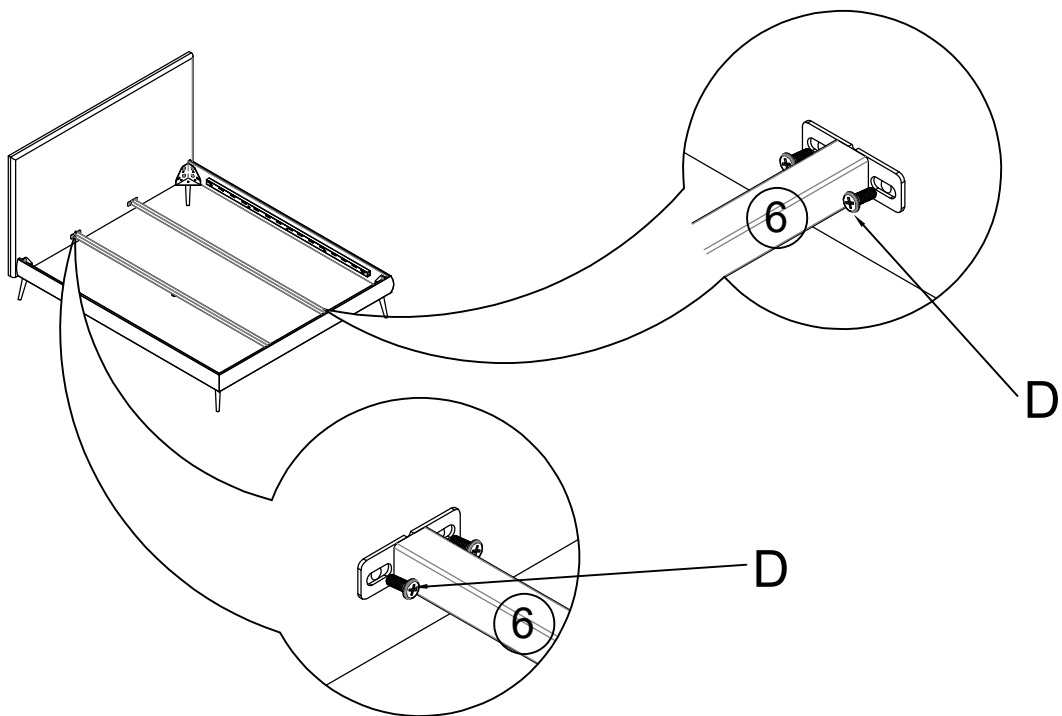

9

B

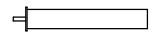

*2

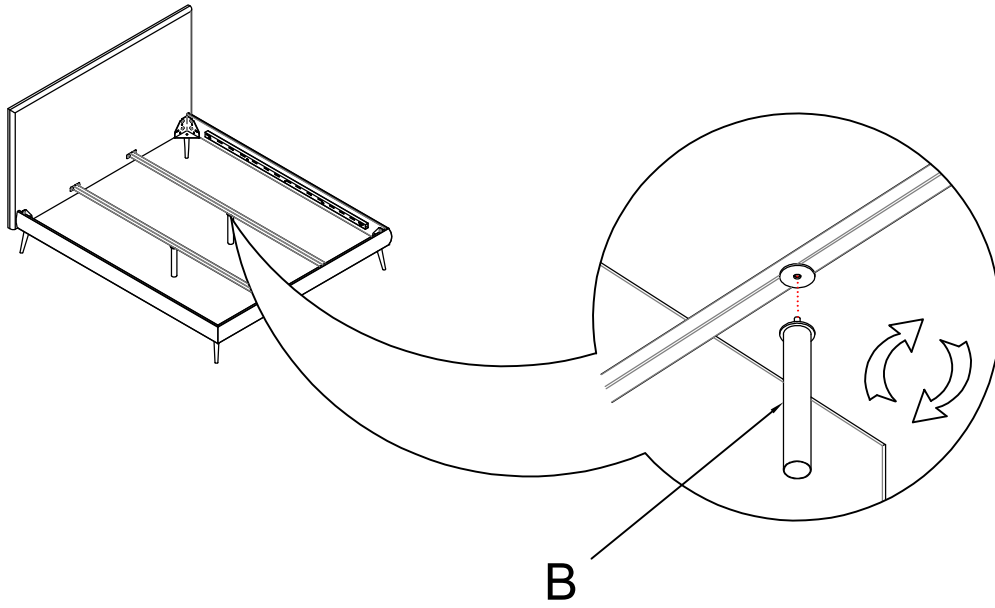

10

F

*15

