

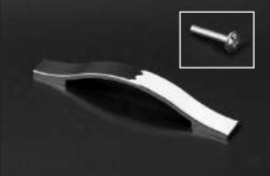









FERRAMENTA / HARDWARE

						
A 24 X SPINE IN LEGNO 8X35 WOODEN LOWEL 8x35	B 2 X MANIGLIA CON VITI HANDLE WITH SCREWS	C 6 X BASETTA A PRESSIONE PER CERNIERA PRESSURE BASE FOR HINGE	D 6 X CERNIERA D.35 COLLO DRITTO HINGE D.35 STRAIGHT NECK	E 4 X SCIVOLO C/CIONDOLI D.8 H.5 NYLON NERO SLIDE C / PENDANTS D.8 H.5 BLACK NYLON	F 12 X VITI MONTAGGIO 7X50 TESTA ESAGONALE 7X50 HEX HEAD MOUNTING SCREWS	G 16 X REGGIPIANO IN PLASTICA ROT. 5-8 ROUND PLASTIC SHELF SUPPORT 5-8
						
H 4 X CHIODI DA 30 MM NAILS OF 30 MM	L 12 X TAPPO VITI MONTAGGIO CAP MOUNTING SCREWS	M 1 X CHIAVINO ESAGONALE MM. 4 ZINC. HEX KEY MM. 4 GALVANIZED	O 1 X PROFILO PER AD H.180 PROFILE FOR AD H.180			

Istruzioni di montaggio scarpiera.

- A) Per evitare graffiature, si consiglia di eseguire il montaggio dell'armadio su una base orizzontale coperta.
B) È consigliato di eseguire il montaggio da 2 persone.

Assembly instructions shoe rack.

- A) To avoid scratches, it is recommended to mount the cabinet on a covered horizontal base.
B) It is recommended to carry out the assembly by 2 people.



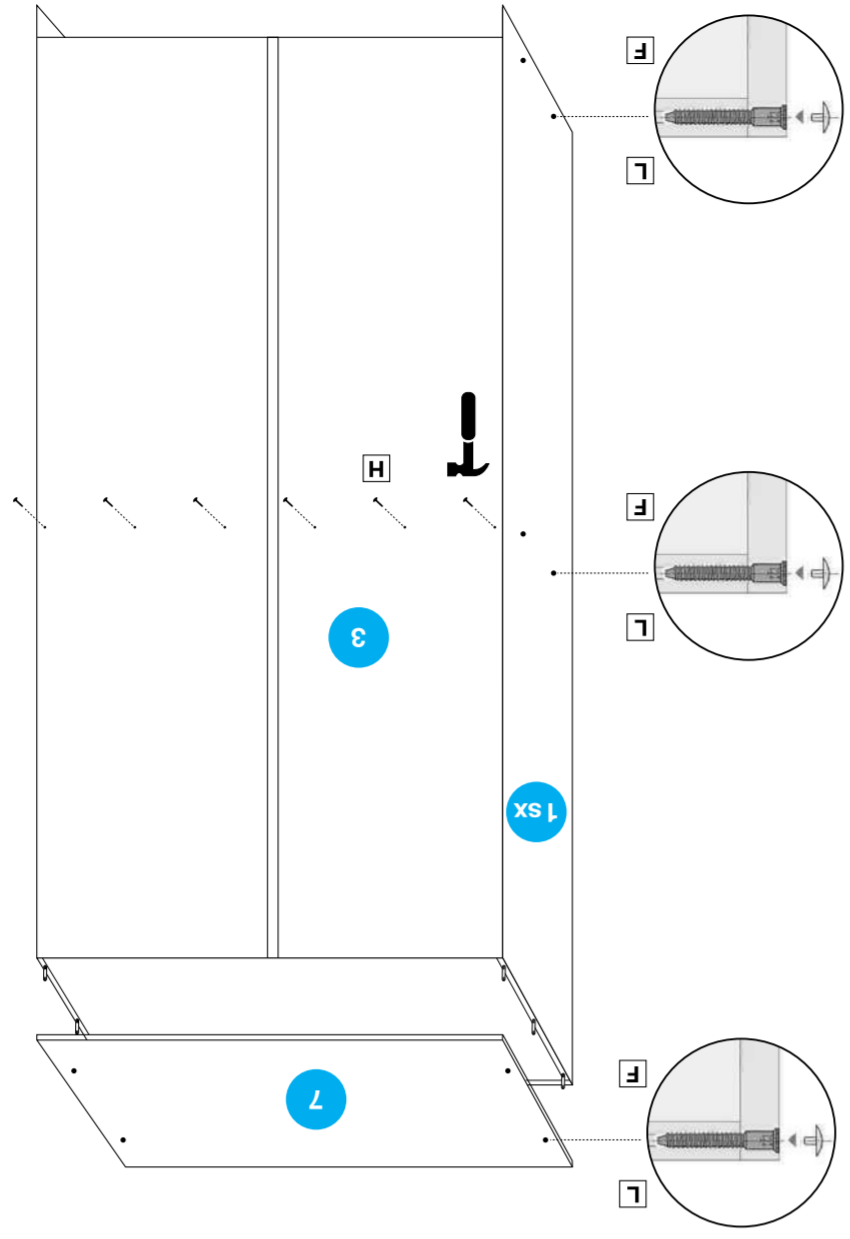

4

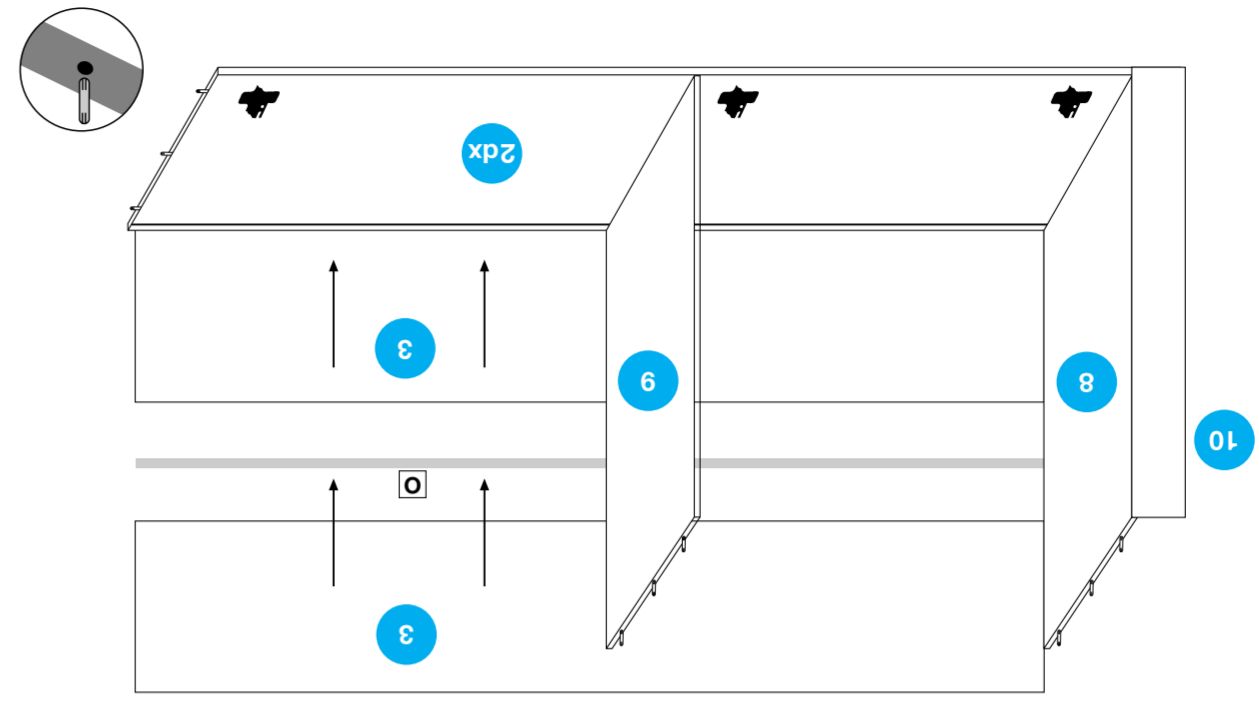

2

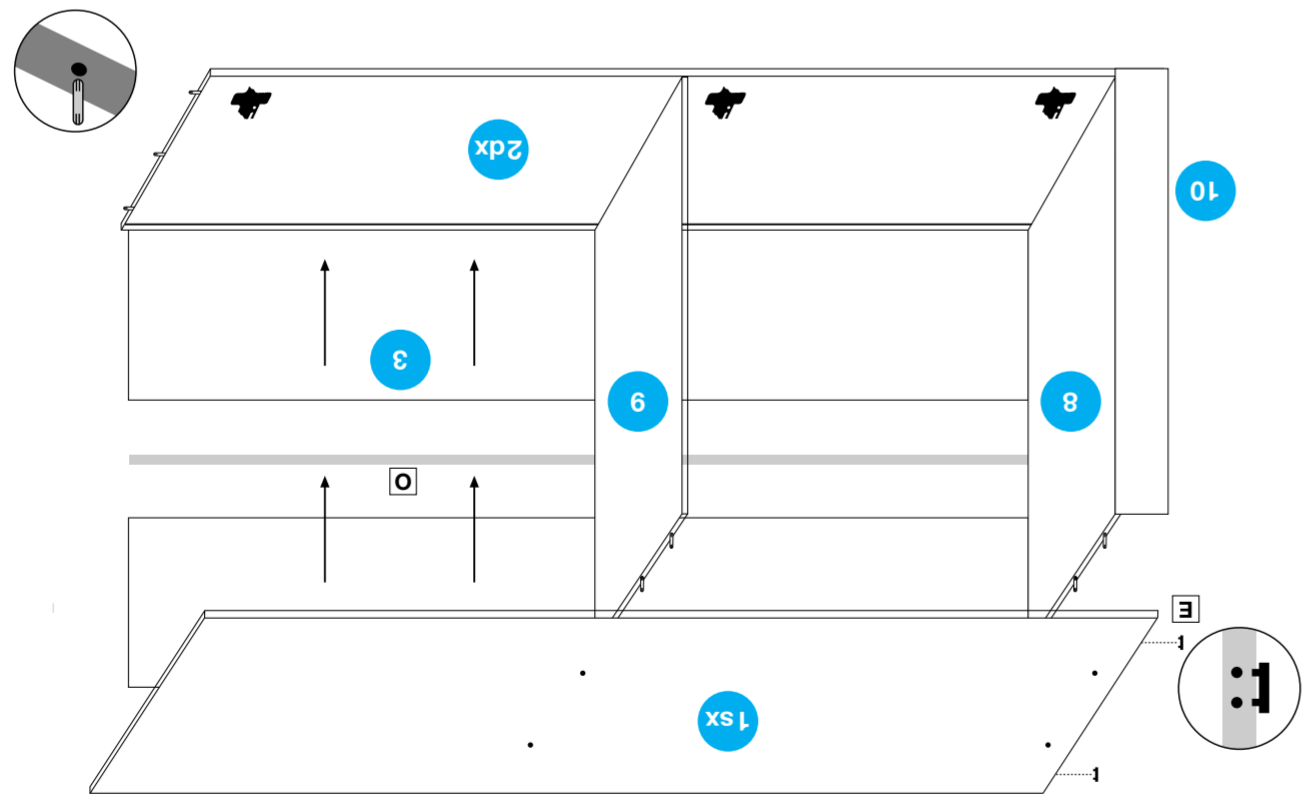

3

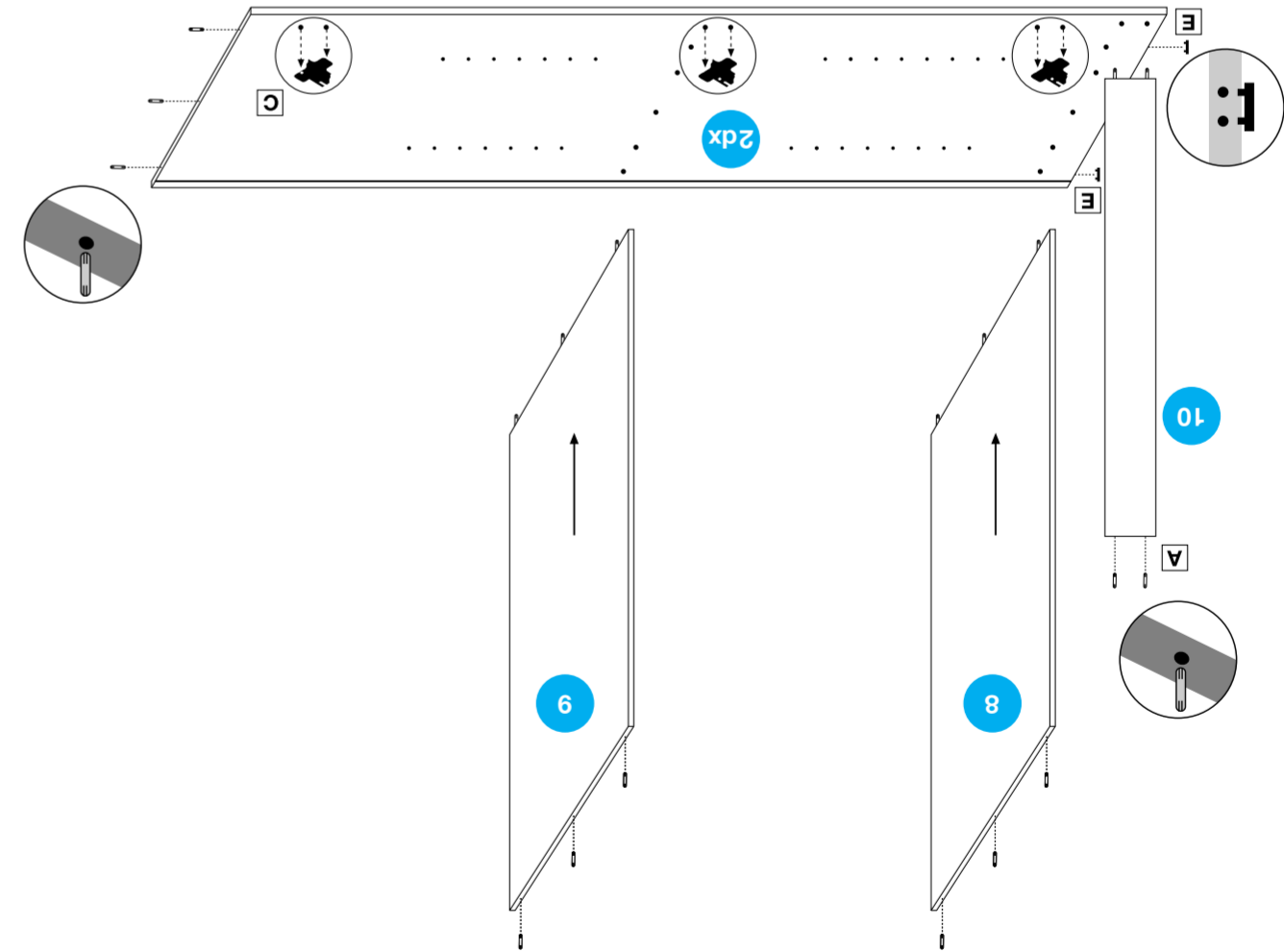

1