

# MOD. SOLEIL

Notice de montage

Assembling scheme

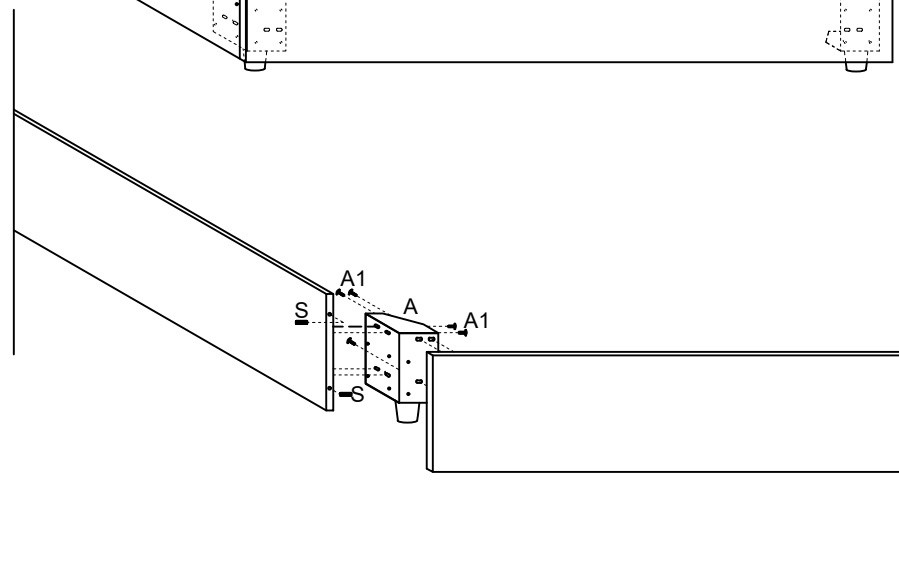
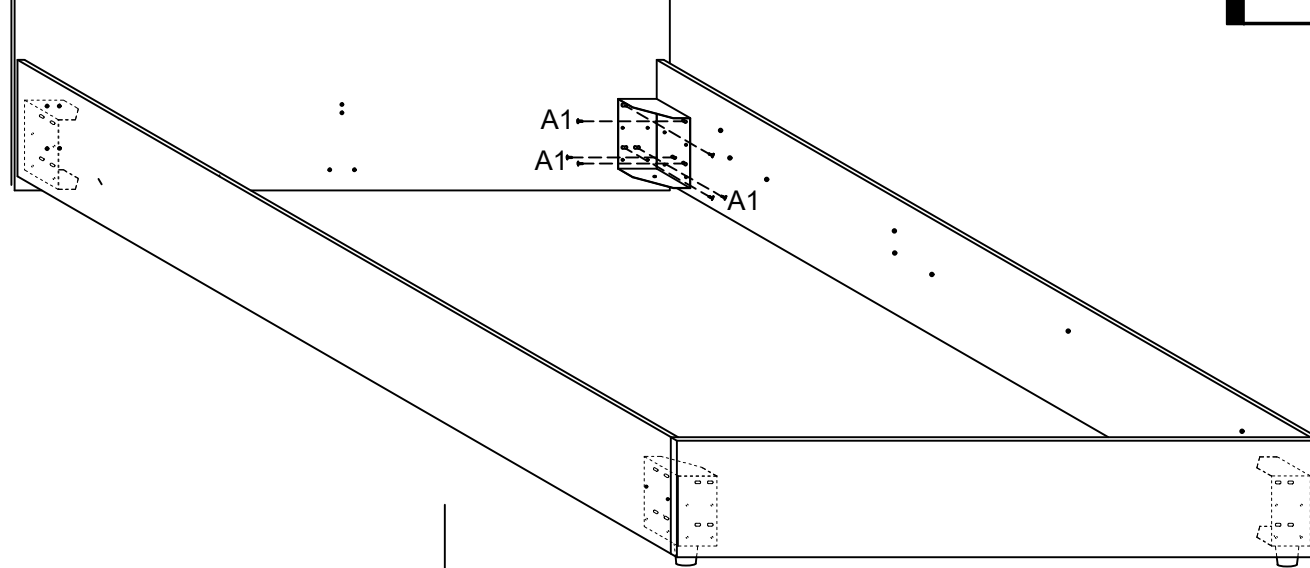
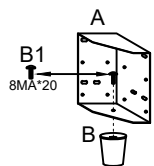
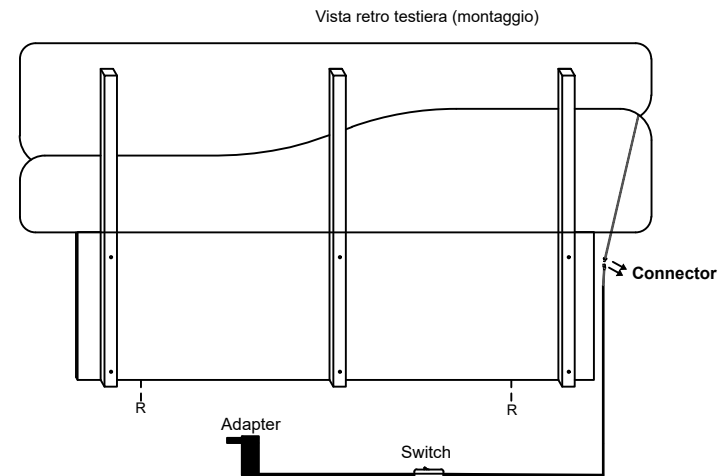
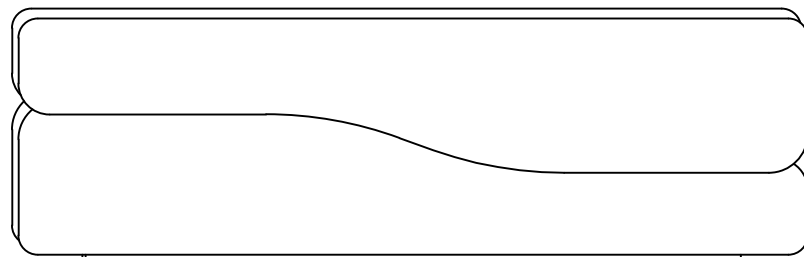

## LETTO

A	cubi contenitori	A1	6MA*15
N°4		N°32	
B	Piedi plastica	B1	8MA*20
N°2		N°2	
S	spine legno 8*30		
		N°8	
R	FELTRINO C/ADESIVO		
		N°2	



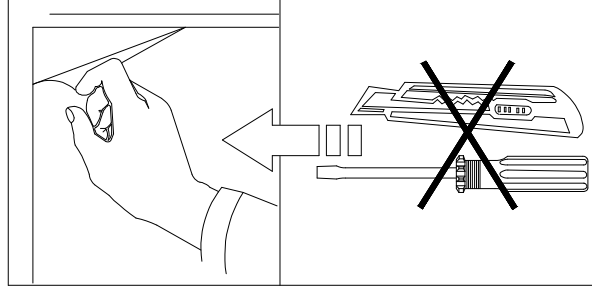
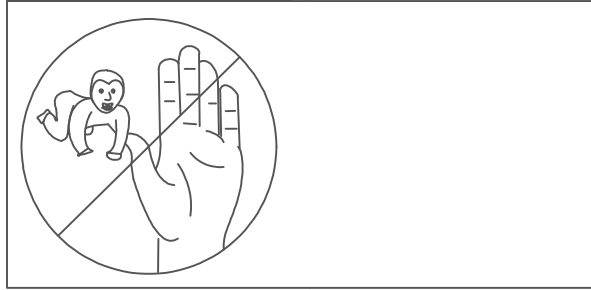
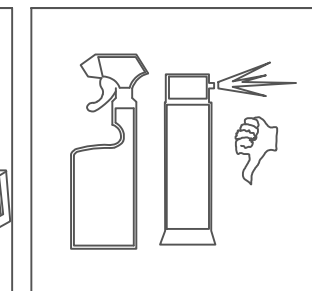
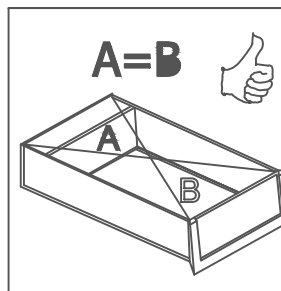
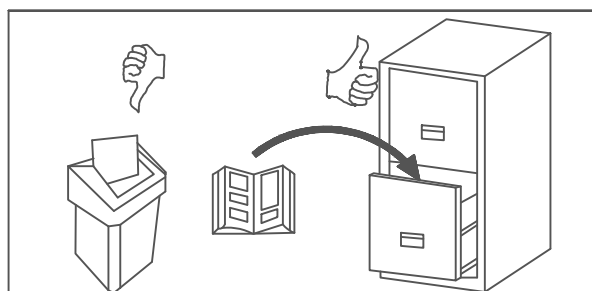
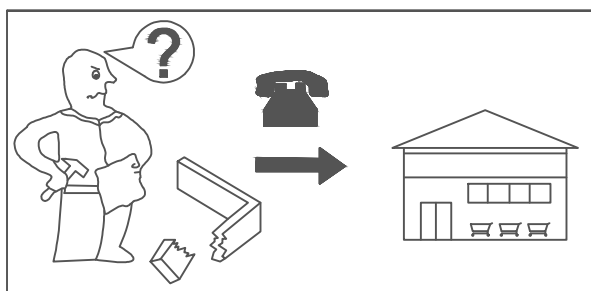
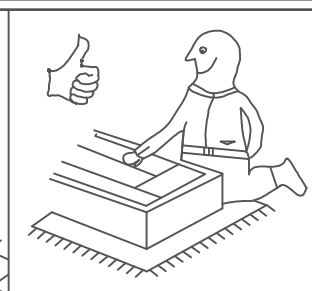
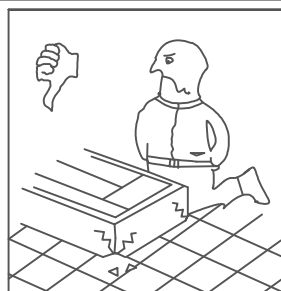
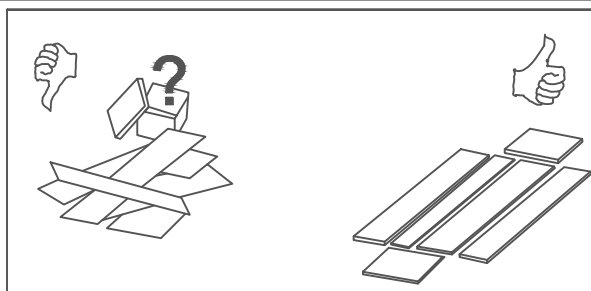
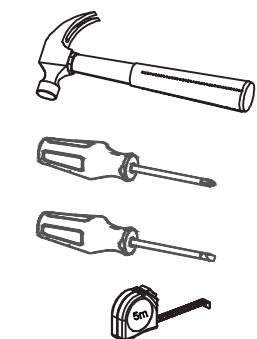
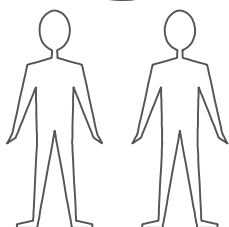
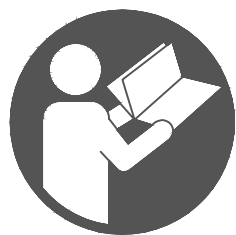
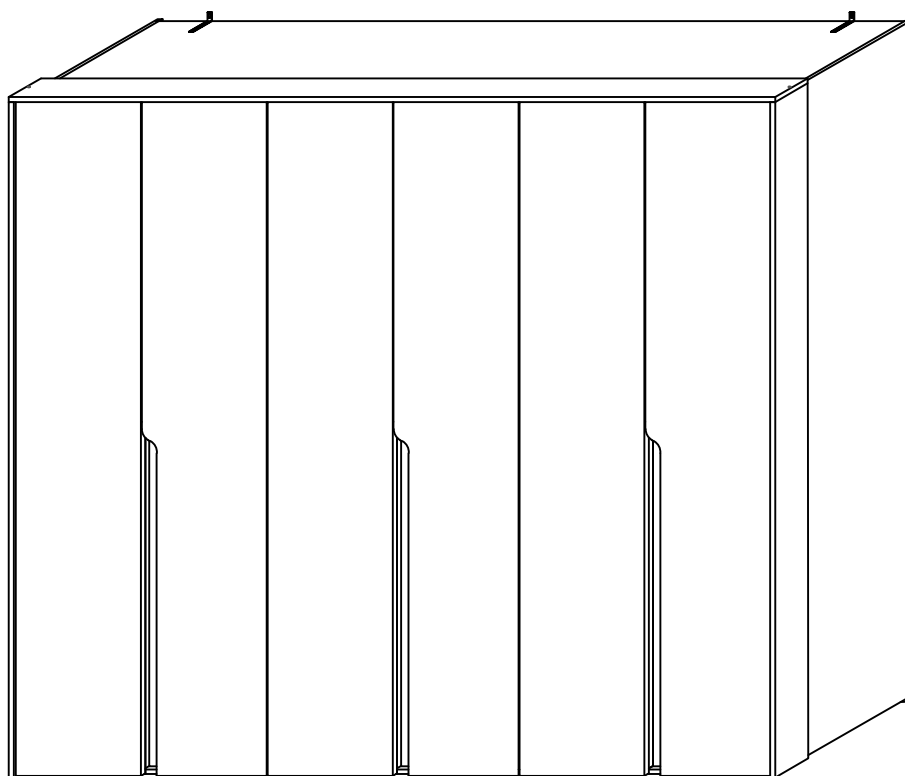



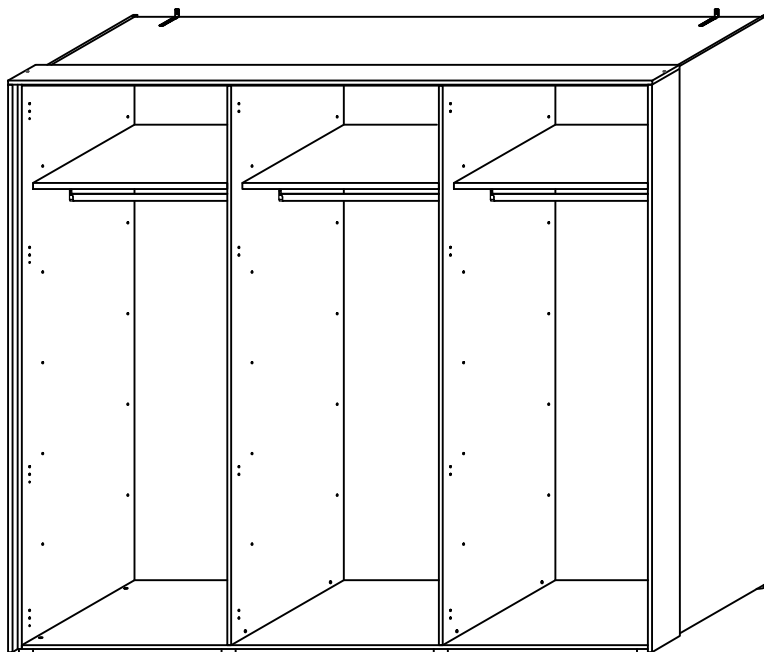



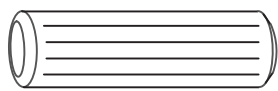
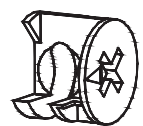
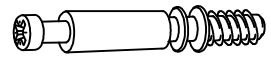

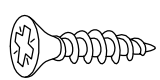

# SOLEIL Wardrobe

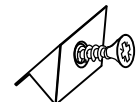

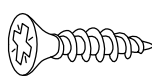
# SOLEIL Wardrobe

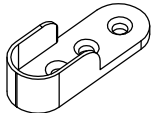
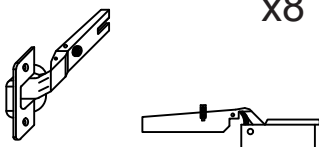
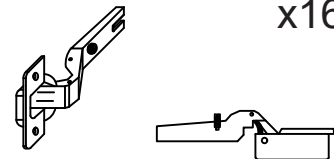

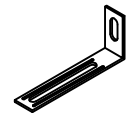
## ASSEMBLY HARDWARE:

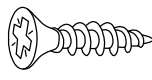
<p><b>A</b> <math>\varnothing 8 \times 30</math> x24</p> 	<p><b>B</b> x16</p> 	<p><b>B1</b> x16</p> 
<p><b>C</b> x12</p> 	<p><b>C1</b> <math>\varnothing 6.3 \times 9</math> x12</p> 	<p><b>D</b> <math>\varnothing 22 \times 12</math> x9</p> 
<p><b>E</b> <math>\varnothing 3.5 \times 15</math> x64</p> 	<p><b>F</b> <math>\varnothing 3.5 \times 30</math> x30 <b>F1</b> <math>\varnothing 3.5 \times 45</math> x9</p> 	<p><b>G</b> <math>\varnothing 60 \times 20</math> x8</p> 
<p><b>H</b> x16</p> 	<p><b>I</b> x18</p> 	<p><b>J</b> <math>\varnothing 3 \times 20</math> x40</p> 
<p><b>K</b> L.870mm x1 <b>K1</b> L.862mm x2</p> 	<p><b>L</b> x6</p> 	<p><b>M</b> x8</p> 
<p><b>N</b> x16</p> 	<p><b>O</b> x24</p> 	<p><b>P</b> x12</p> 
<p><b>Q</b> x2</p> 	<p><b>K</b> x2</p> 	<p><b>S</b> <math>\varnothing 4 \times 16</math> x2 <b>S1</b> <math>\varnothing 3.5 \times 35</math> x2</p> 

SOLEIL  
Wardrobe

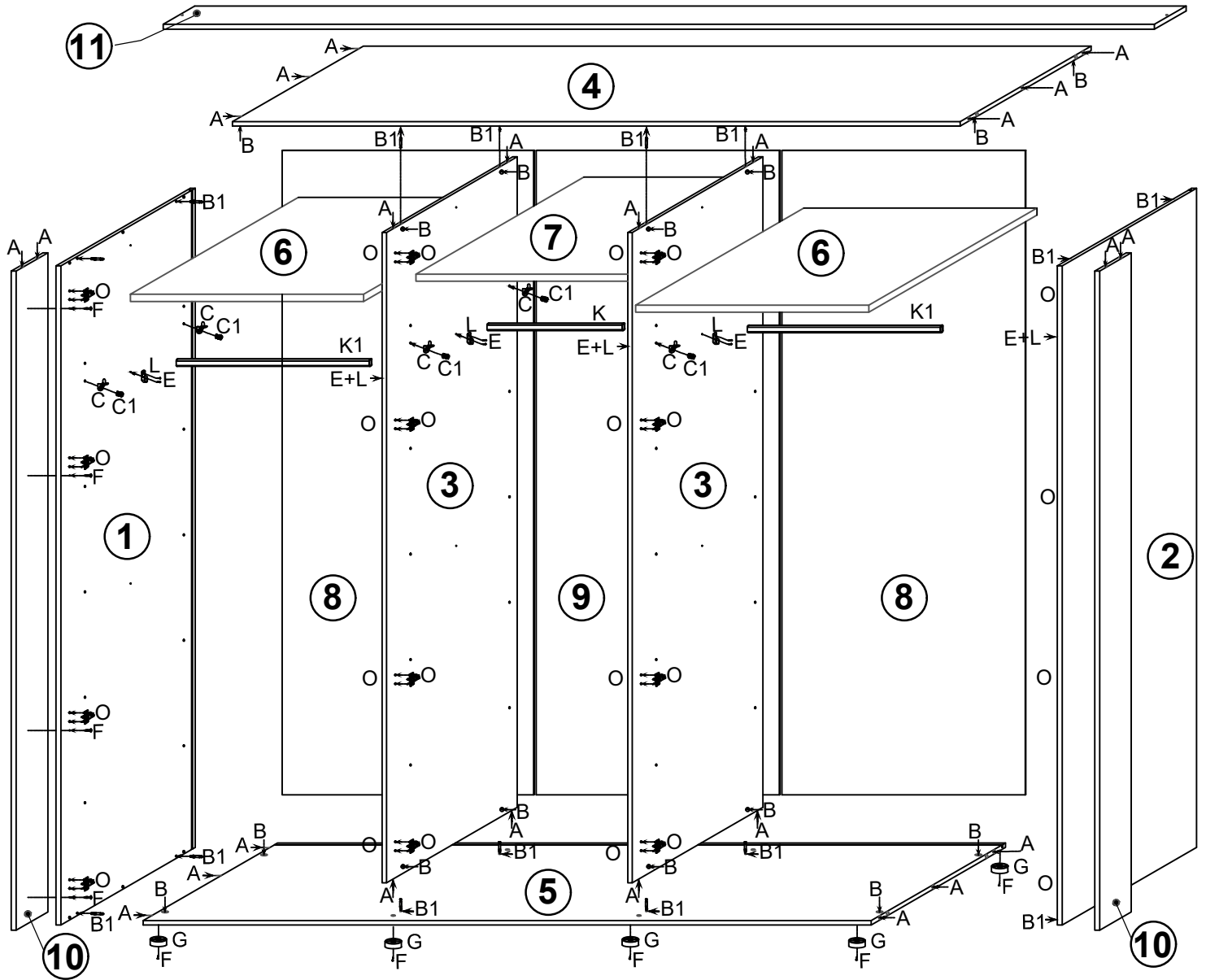

1

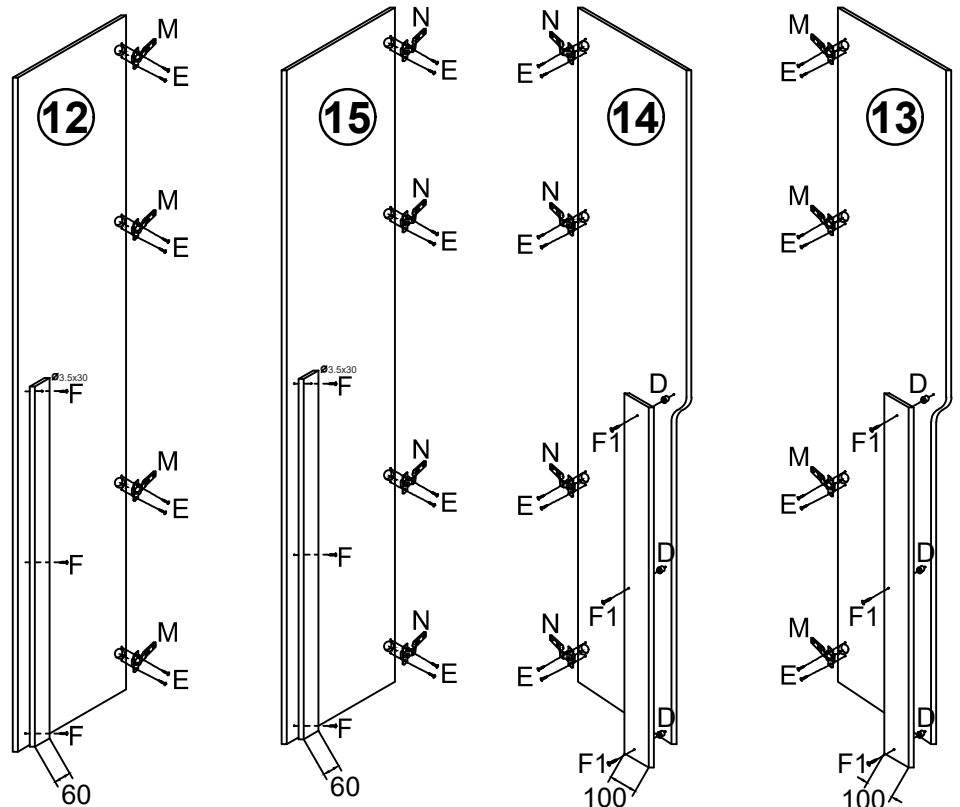
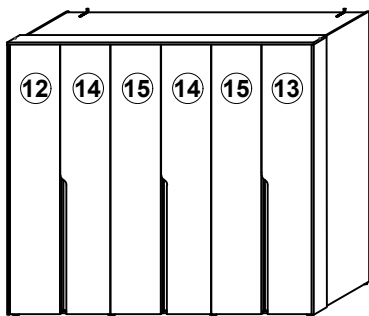

M			8st.
N			16st.
E			48st.
D			9st.
F1			9st.
F			9st.

SOLEIL  
Wardrobe

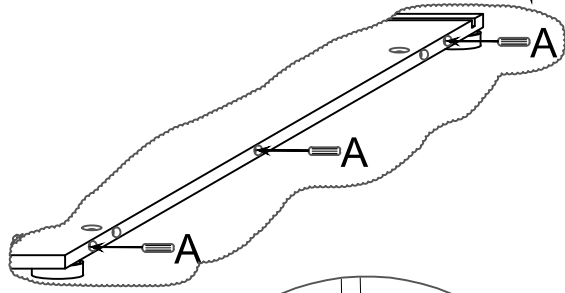
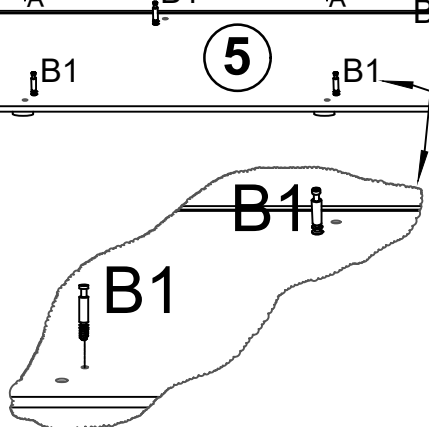
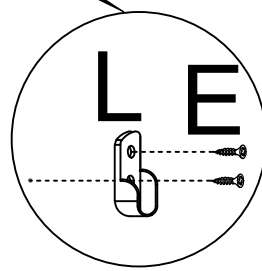
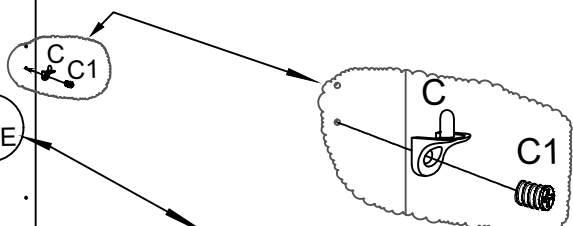
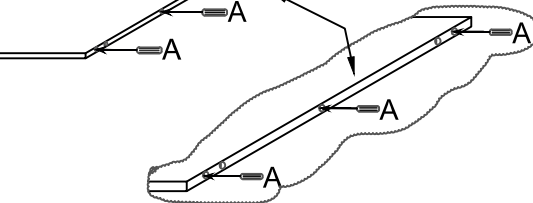
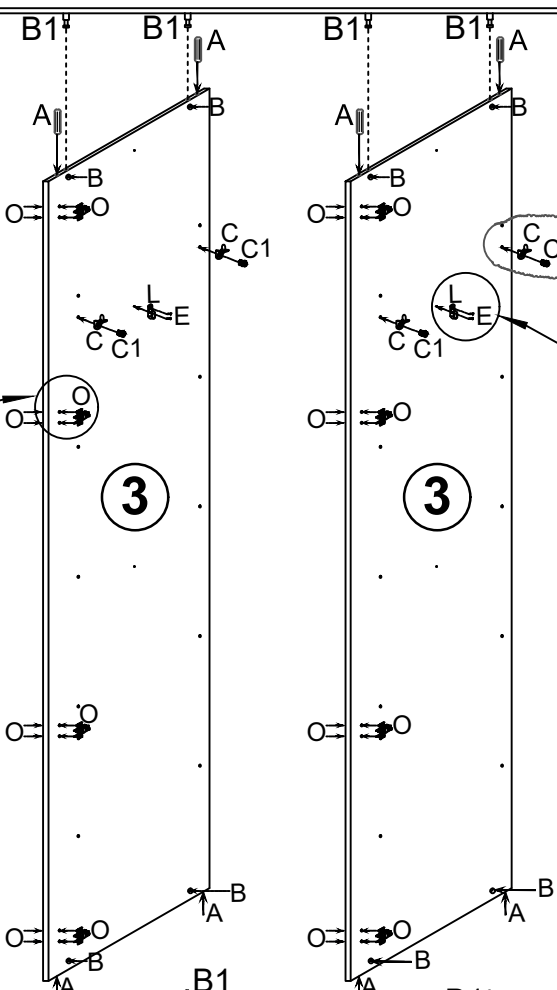
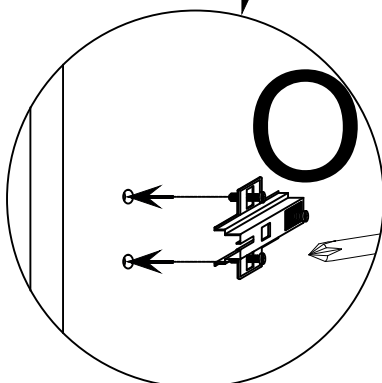
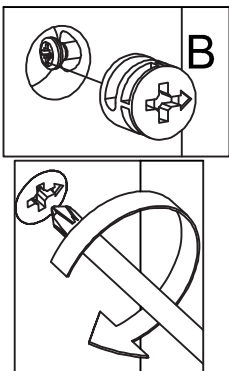
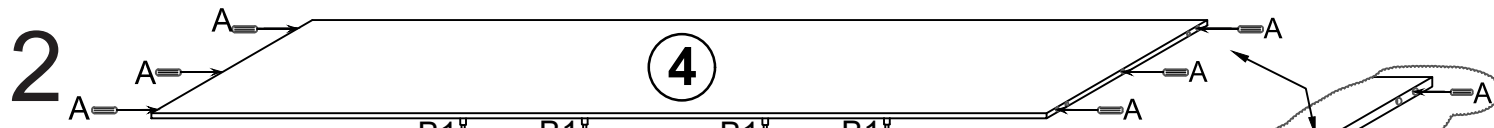
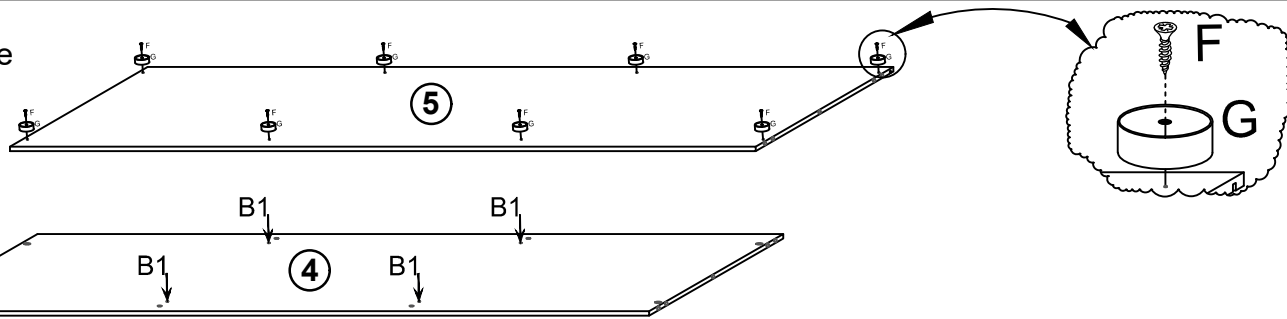

A		20st.
B		8st.
B1		8st.
C		8st.
C1		8st.
J		4st.
E		12st.

O		16st.
G		8st.
F		8st.

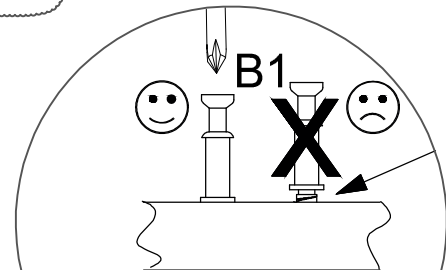

SOLEIL  
Wardrobe

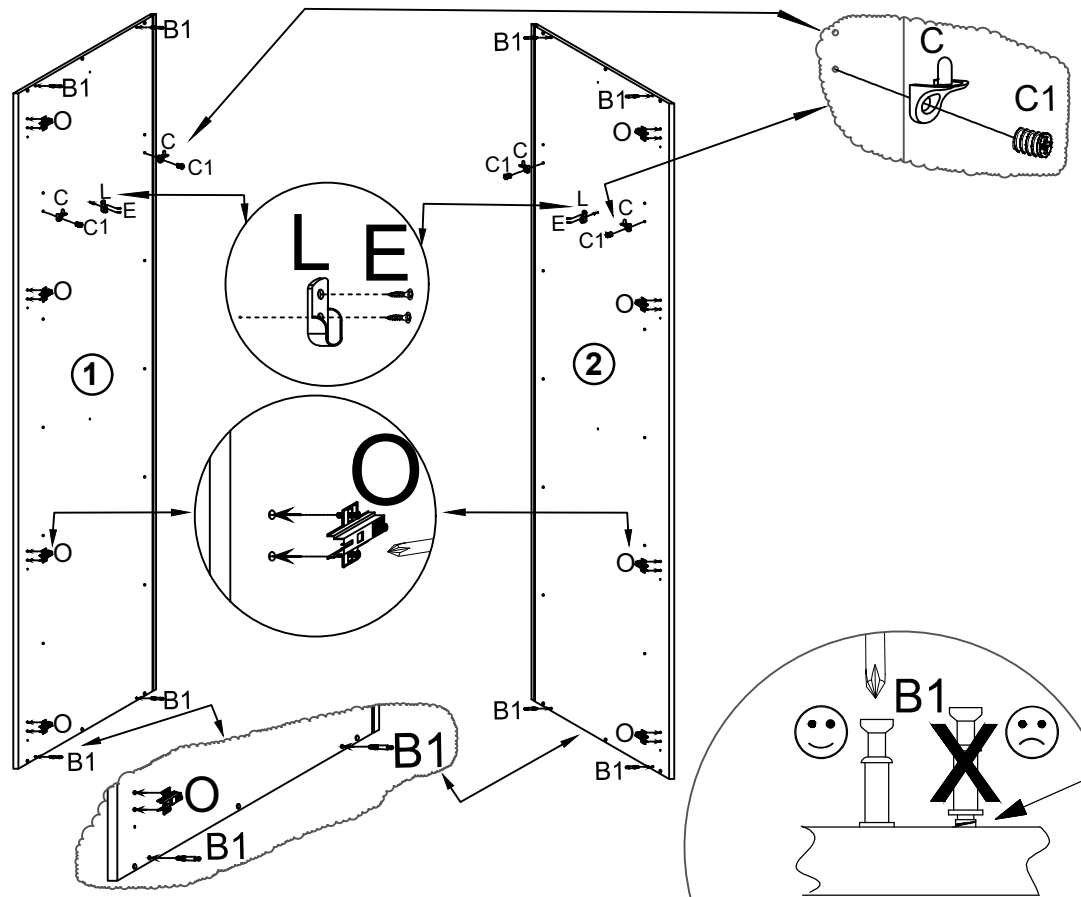

B		8st.
B1		8st.
C		4st.
C1		4st.
J		2st.
E		6st.
O		8st.

3

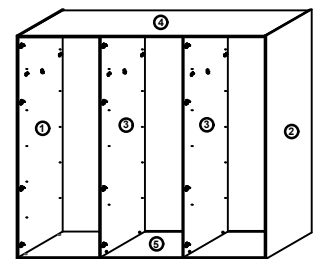
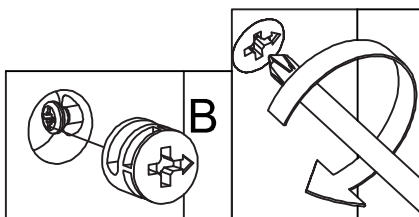
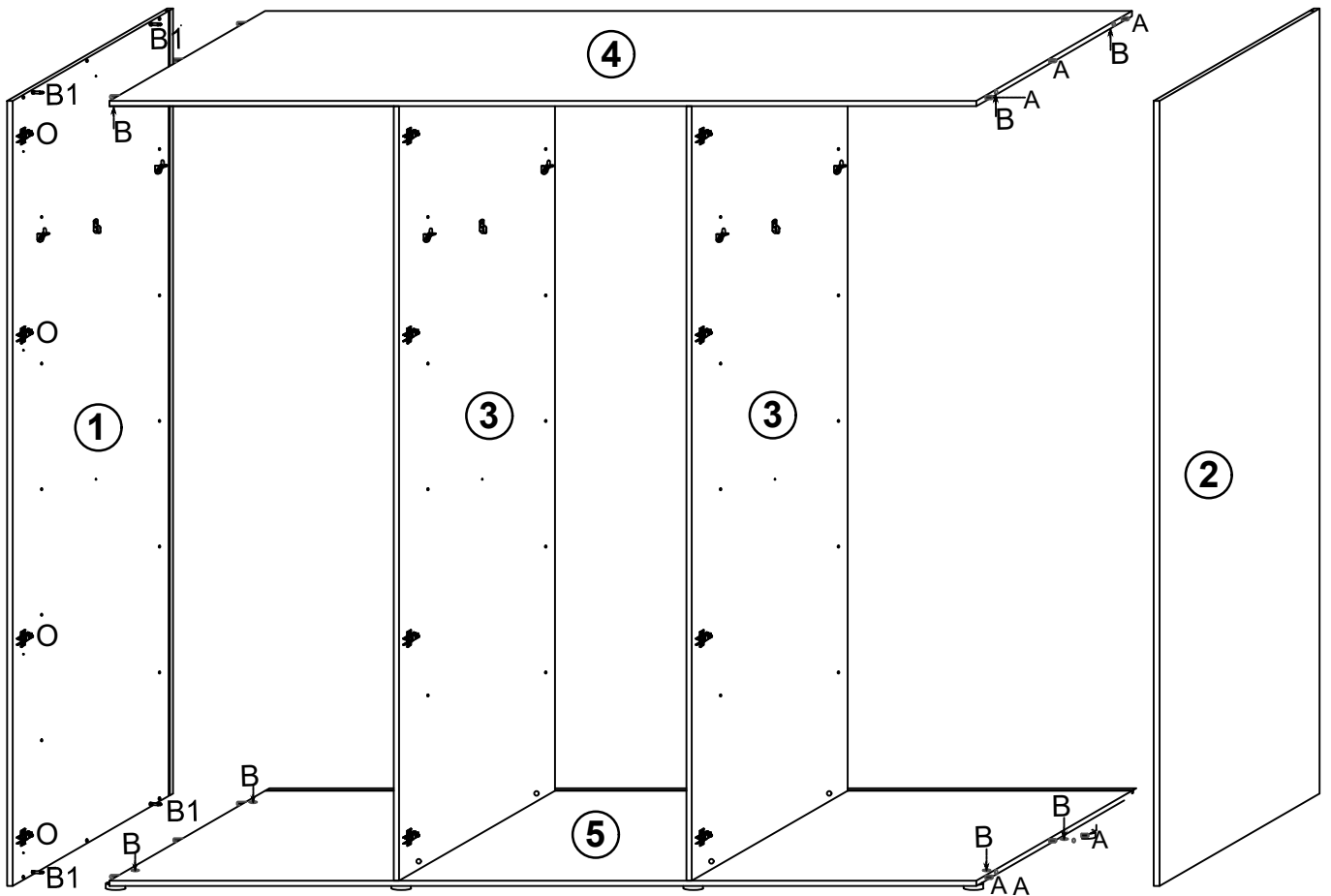

SOLEIL  
Wardrobe

4



$a = b$

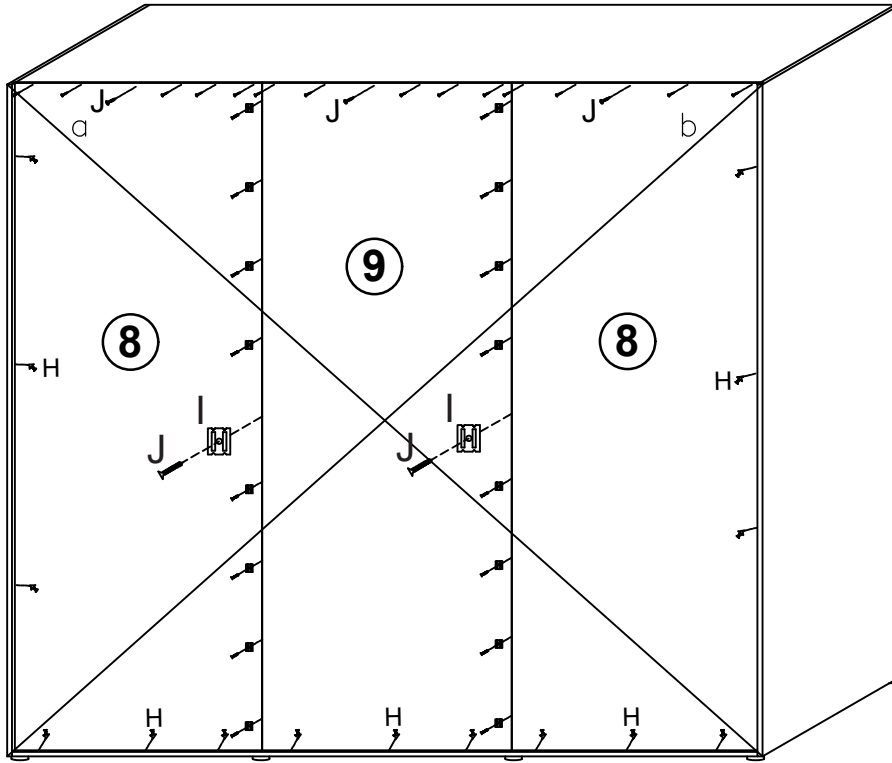

H		16st.
I		18st.
J		40st.

5

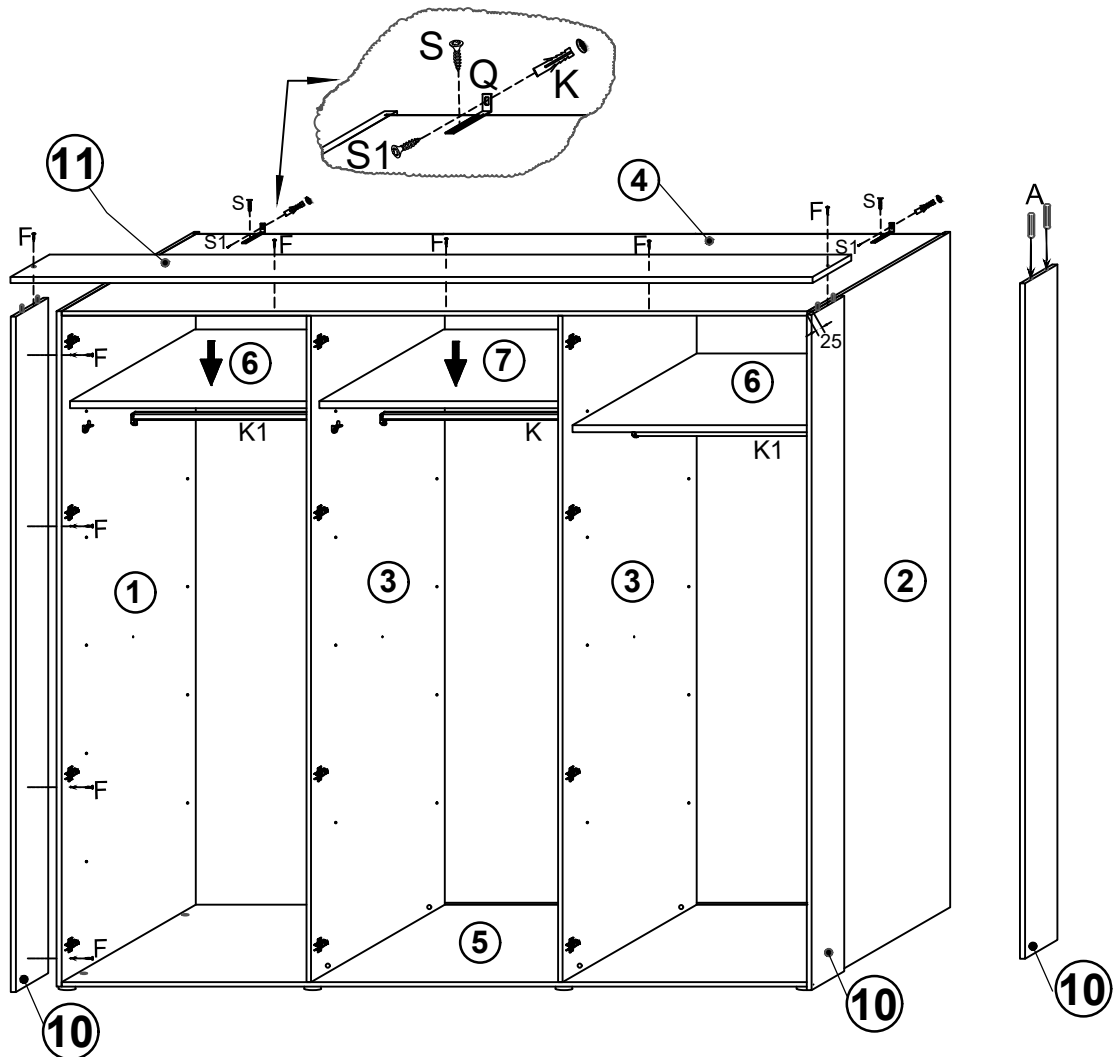

A		4st.
F		13st.
Q		2st.
K		2st.
S		2st.
S1		2st.

# SOLEIL dresser

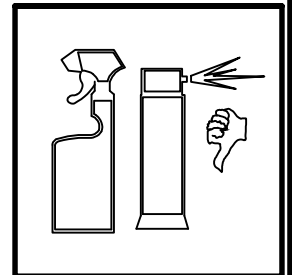
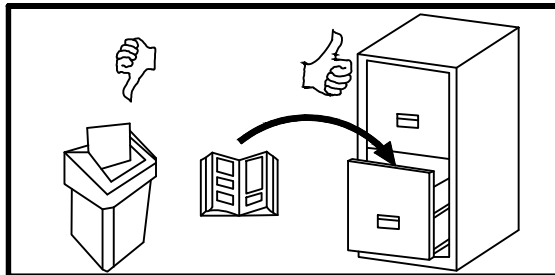
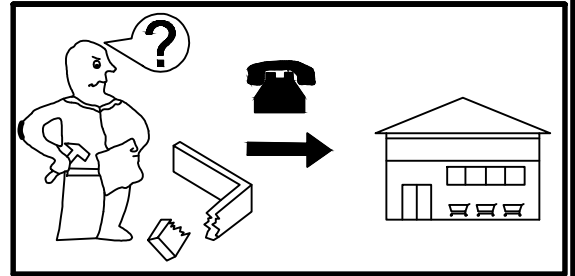
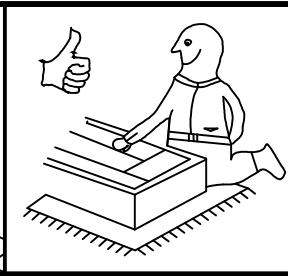
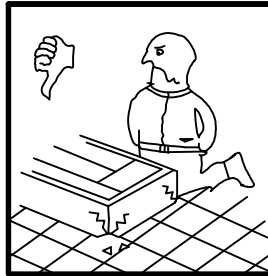
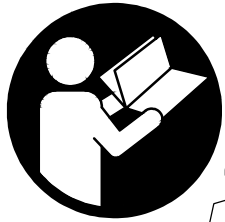
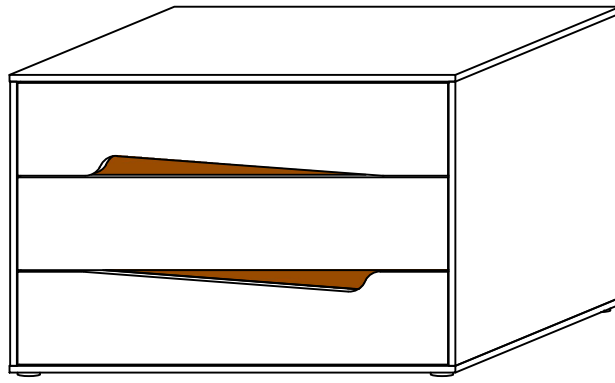

00:12:00

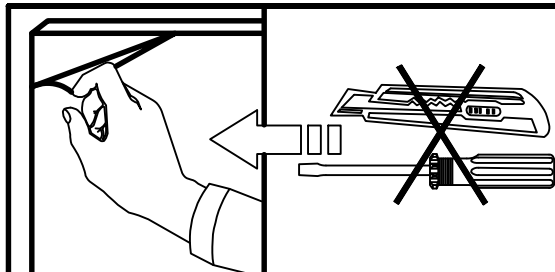

ASSEMBLY HARDWARE:

## ASSEMBLY PARTS :

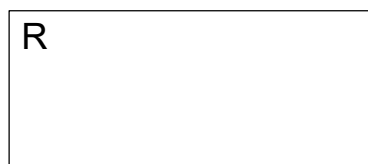
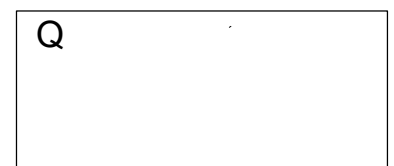
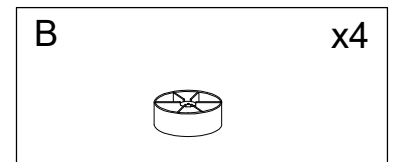
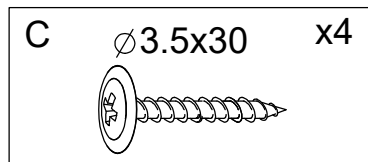
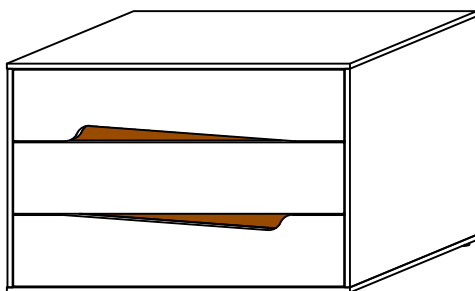



step 1.

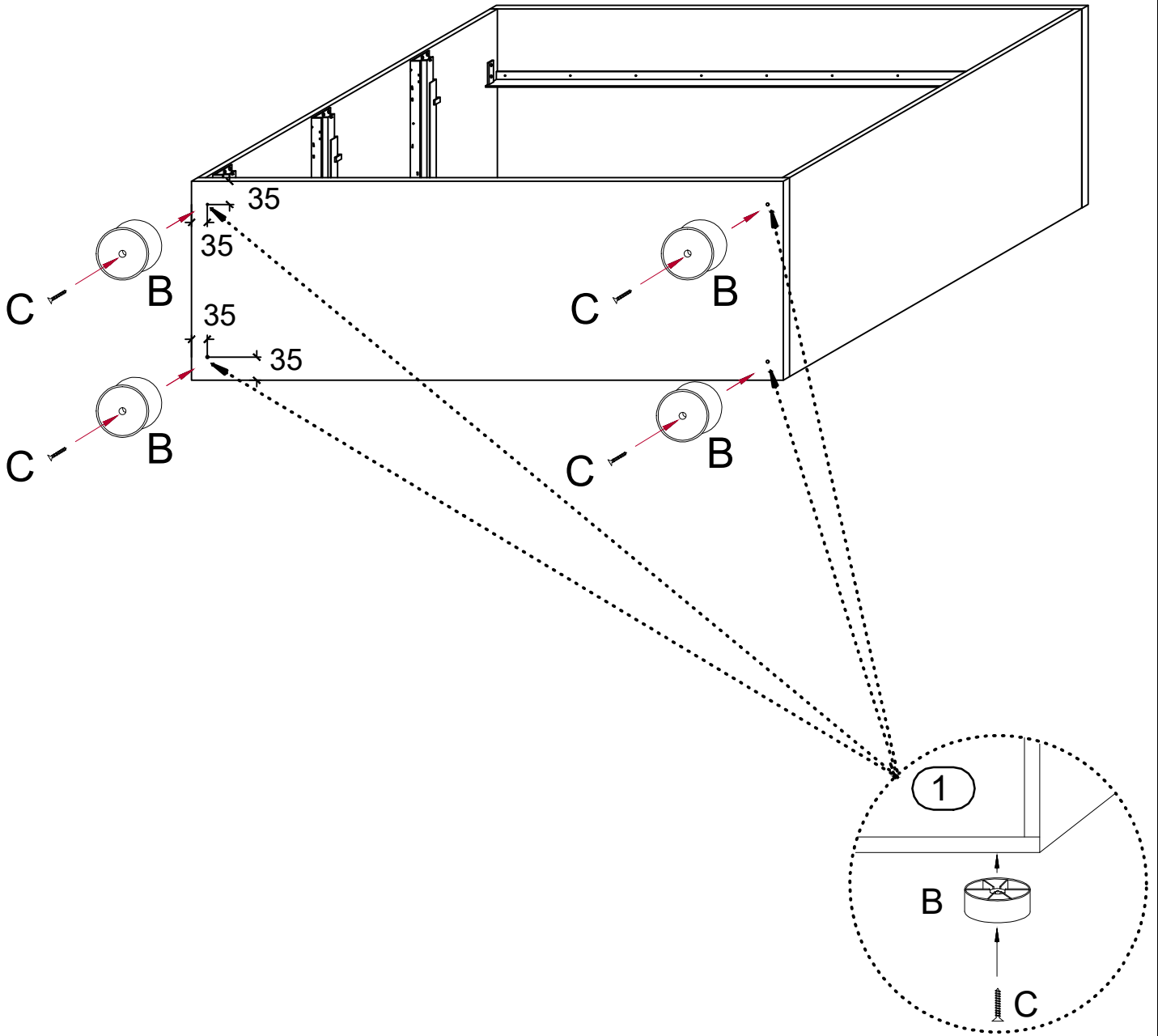

# SOLEIL nightstand

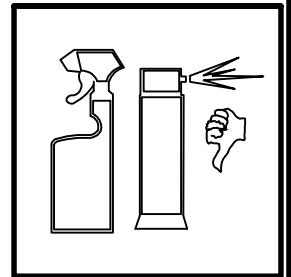
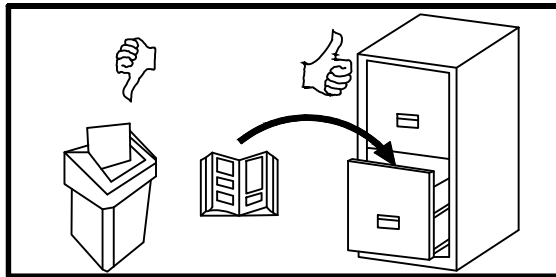
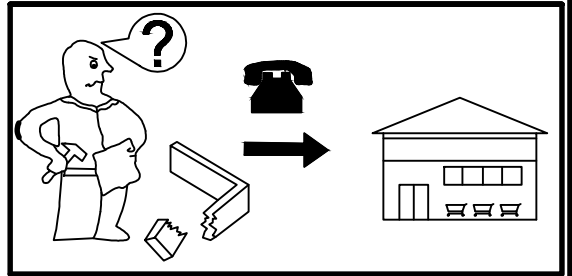
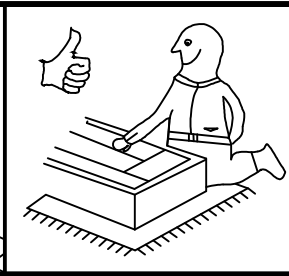
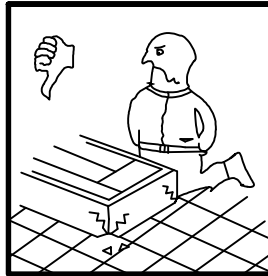
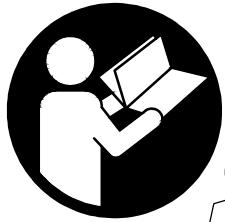
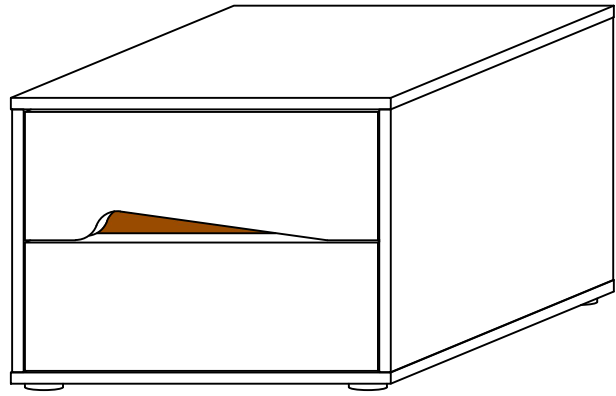

00:12:00

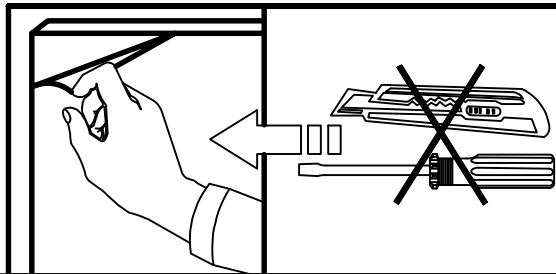

ASSEMBLY HARDWARE:

## ASSEMBLY PARTS :

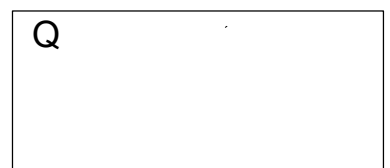
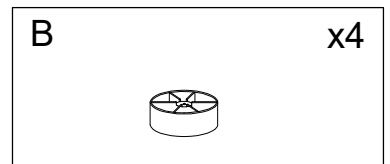
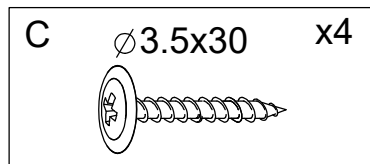
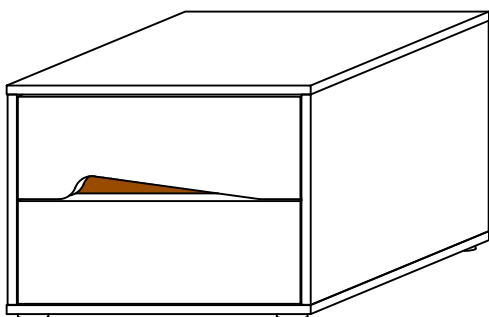

step 1.

