

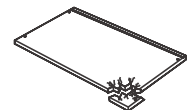

Modell **BERNO KOMODA 4SH2D BR0004**

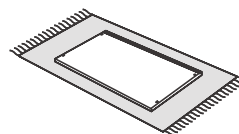

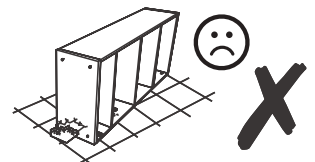

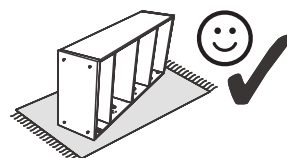
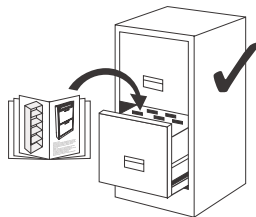
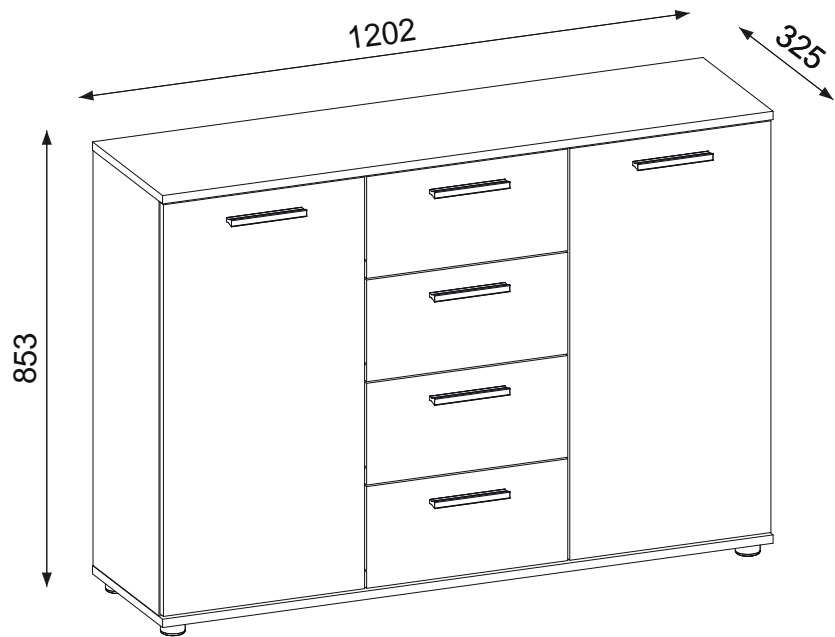
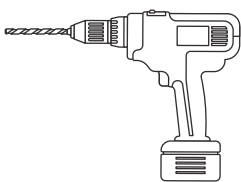
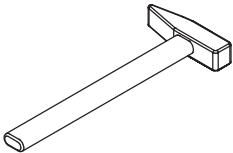
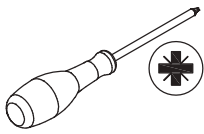
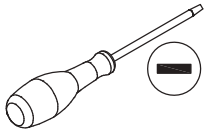
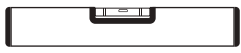
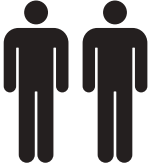
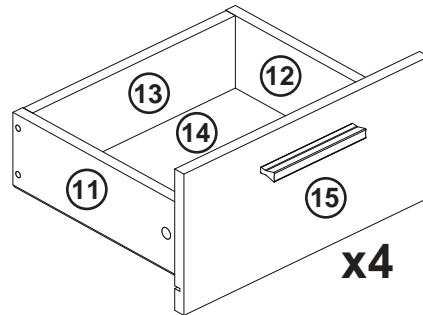
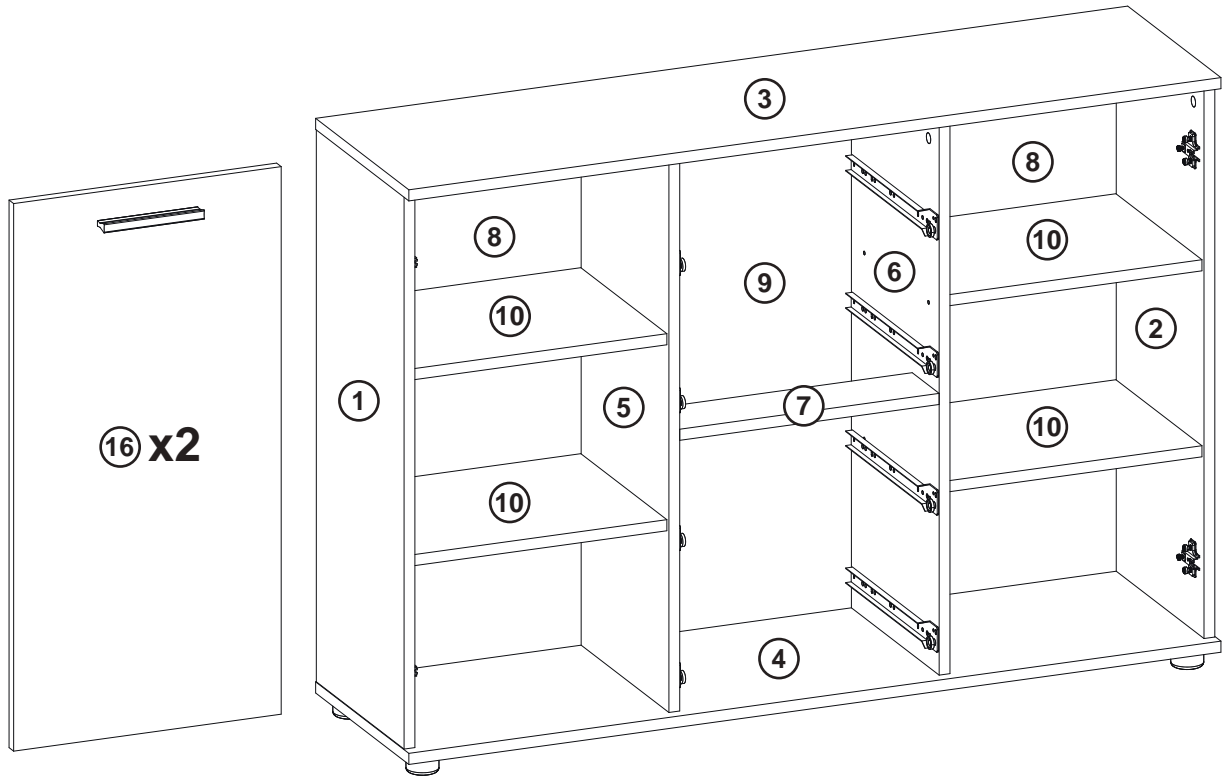



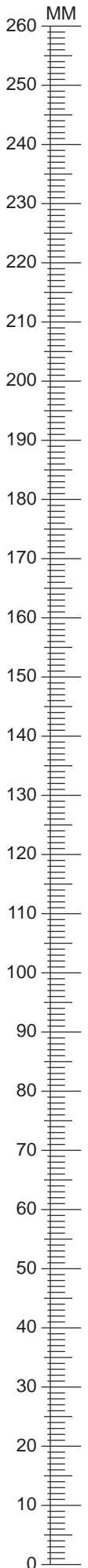
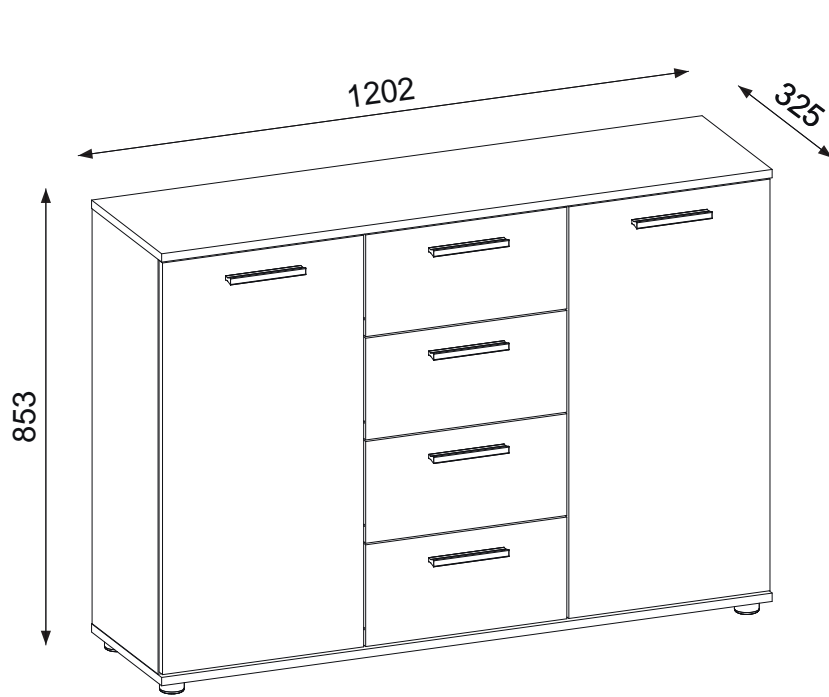

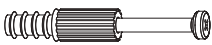

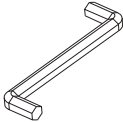
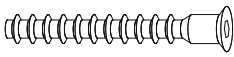





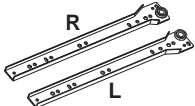
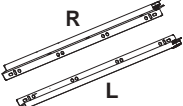

A	B (mm)		C	D	
1	796	306	16	x1	1/2
2	796	306	16	x1	1/2
3	1202	325	16	x1	1/2
4	1202	325	16	x1	1/2
5	796	306	16	x1	1/2
6	796	306	16	x1	1/2
7	384	94	16	x1	2/2
8	824	398	2.5	x2	2/2
9	824	398	2.5	x1	2/2

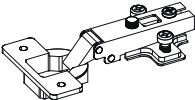
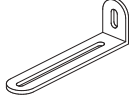
A	B (mm)		C	D	
10	375	300	16	x4	2/2
11	300	100	16	x4	1/2
12	300	100	16	x4	1/2
13	328	100	16	x4	2/2
14	358	306	2.5	x4	2/2
15	396	195	16	x4	2/2
16	396	789	16	x2	2/2

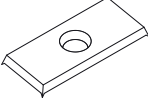

<p>18x</p>  <p>45mm <b>r23</b></p>	<p>18x</p>  <p>Ø 15x12mm <b>r1</b></p>	<p>8x</p>  <p>Ø 20mm <b>s2</b></p>
<p>1x</p>  <p>4mm <b>z1</b></p>	<p>24x</p>  <p>Ø 6,3x50mm <b>e27</b></p>	<p>34x</p>  <p>Ø 8x30mm <b>f1</b></p>
<p>16x</p>  <p>Ø 6,3x13mm <b>e1</b></p>	<p>12x</p>  <p>Ø 4,2x25mm <b>p25</b></p>	<p>26x</p>  <p>Ø 3x16mm <b>p50</b></p>
<p>56x</p>  <p>Ø 2x20mm <b>g1</b></p>	<p>4x</p>  <p>L=300mm <b>n1/1</b></p>	<p>4x</p>  <p>L=300mm <b>n1/2</b></p>
<p>6x</p>  <p>25x45x45mm <b>k43</b></p>	<p>6x</p>  <p>L=128/148mm <b>c242</b></p>	<p>16x</p>  <p>Ø 5mm <b>d1</b></p>
<p>4x</p>  <p>Ø 35mm <b>ab1</b></p>	<p>2x</p>  <p>L=75x25x15mm <b>n14/2</b></p>	<p>8x</p>  <p>Ø 3,5x16mm <b>p51</b></p>
<p>6x</p>  <p>L=20x10x2mm <b>n108</b></p>		<p>6x</p>  <p>Ø 4x25mm <b>p23</b></p>

# 1

f1 x 8



Ø 8x30mm

r1 x 4



Ø 15x12mm

b1 x 4



40x50x12mm

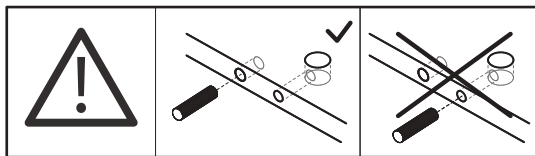
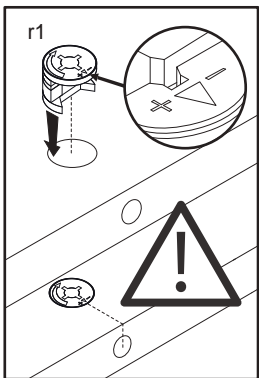
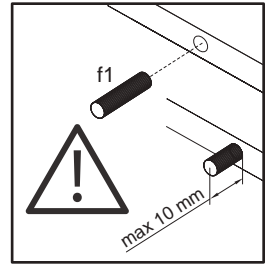
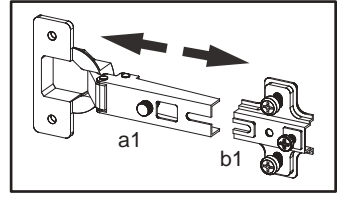
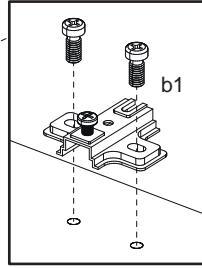
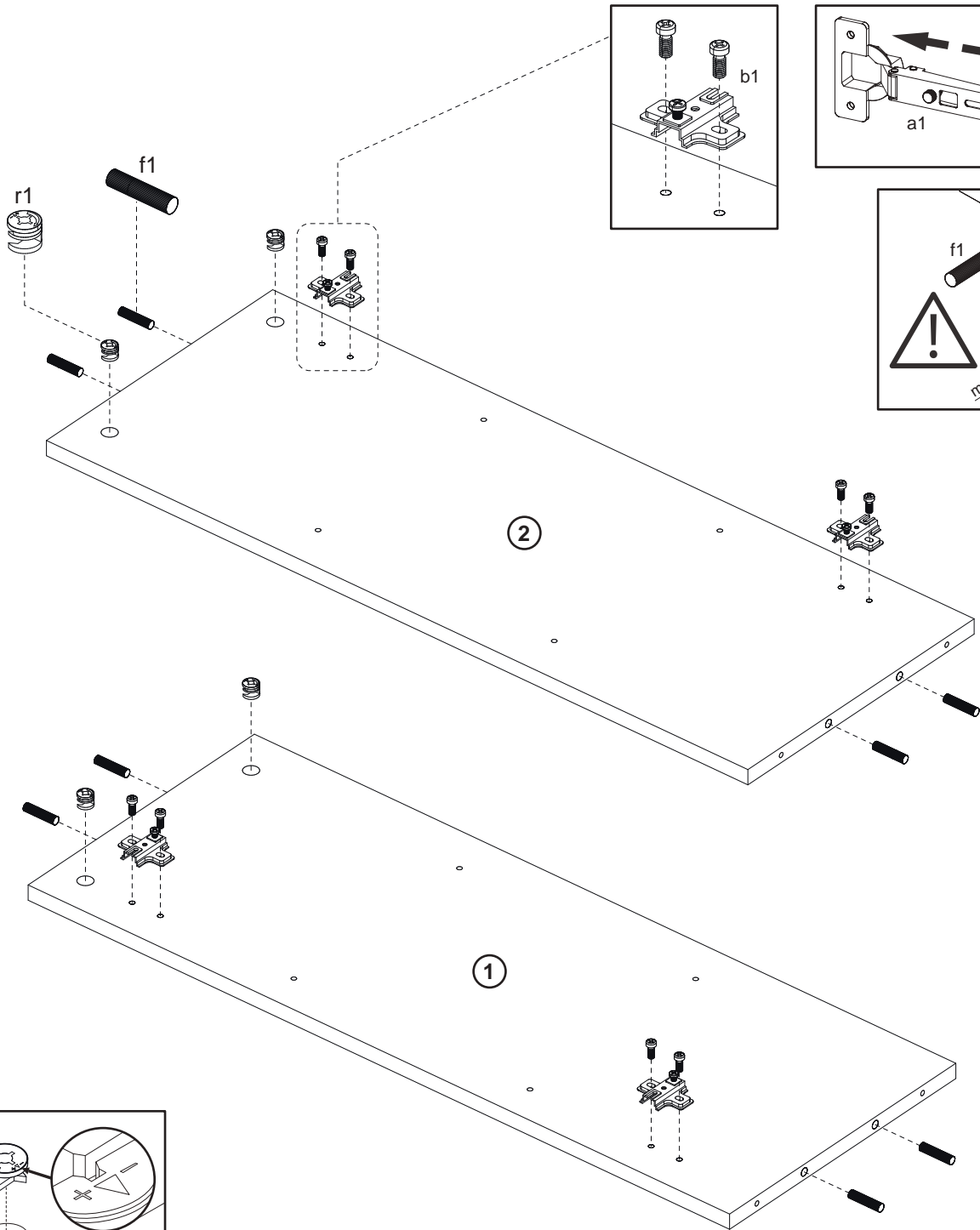

# 2

f1 x 8



Ø 8x30mm

r1 x 4



Ø 15x12mm

r23 x 2



45mm

n1/1 x 4

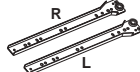



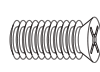

L=300mm

e1 x 16

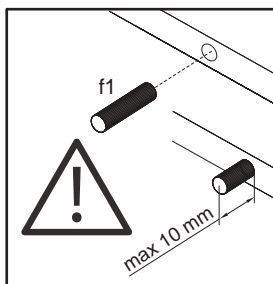
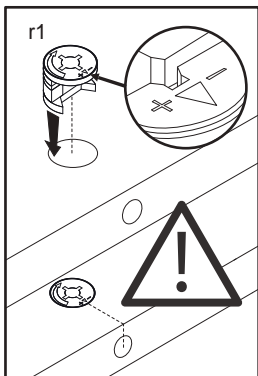
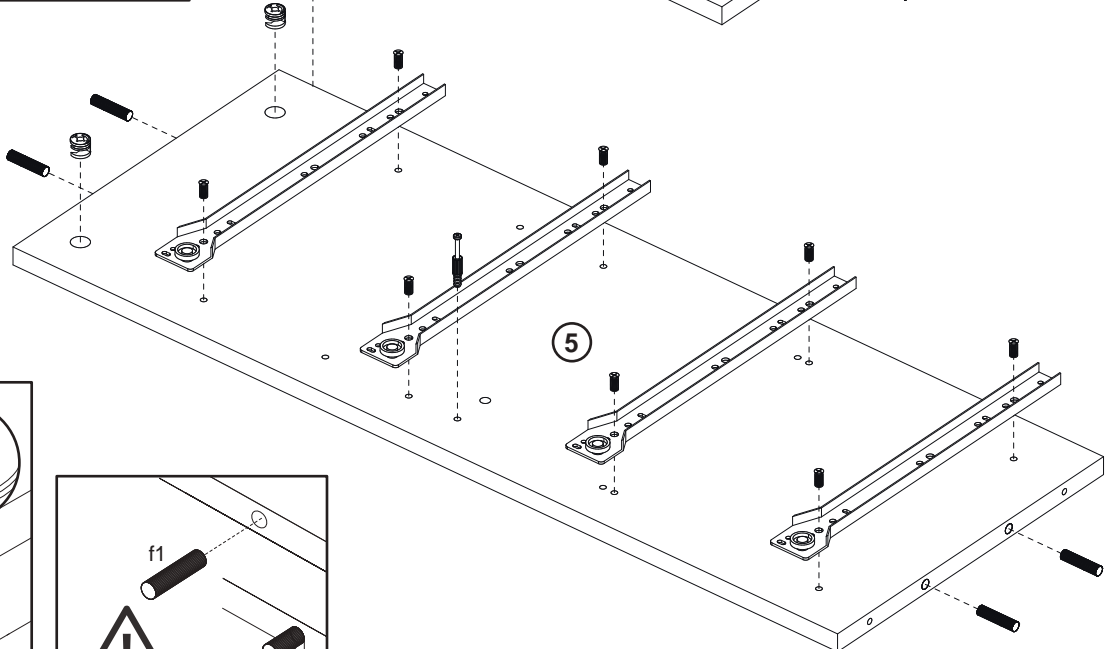
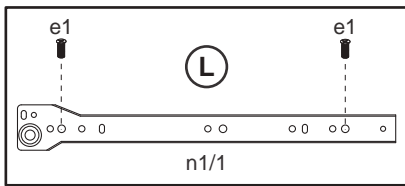
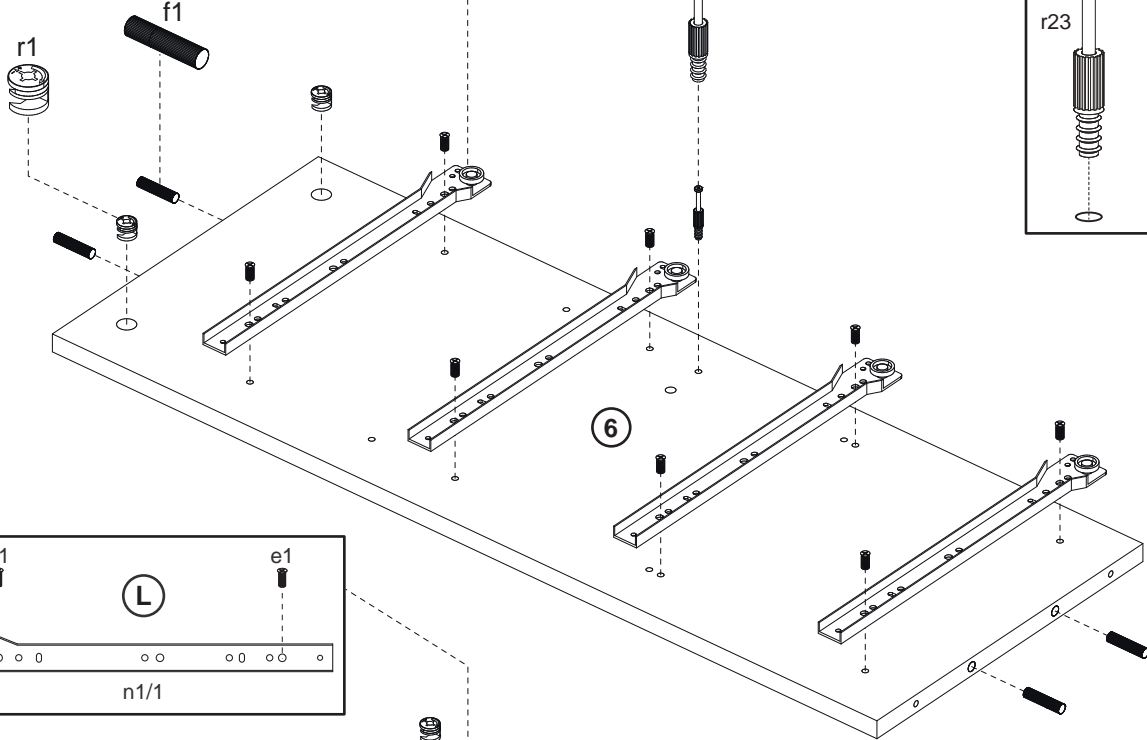
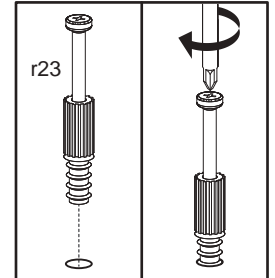
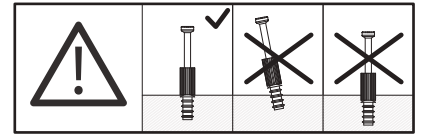
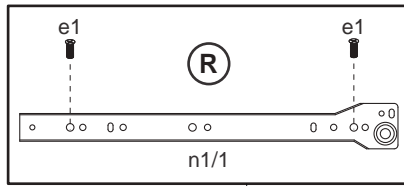

Ø 6,3x13mm

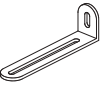

<h1>3</h1>	<p>f1 x 2</p>  <p>Ø 8x30mm</p>	<p>r1 x 2</p>  <p>Ø 15x12mm</p>	<p>r23 x 8</p>  <p>45mm</p>	<p>p50 x 4</p>  <p>Ø 3x16mm</p>	<p>n14/2 x 2</p>  <p>L=75x25x15mm</p>
------------	---	--	--	--	---

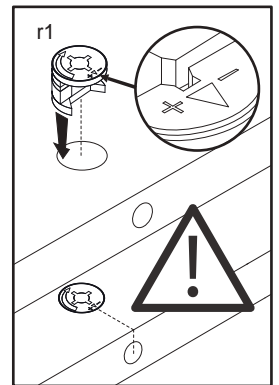
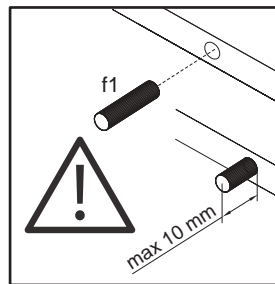
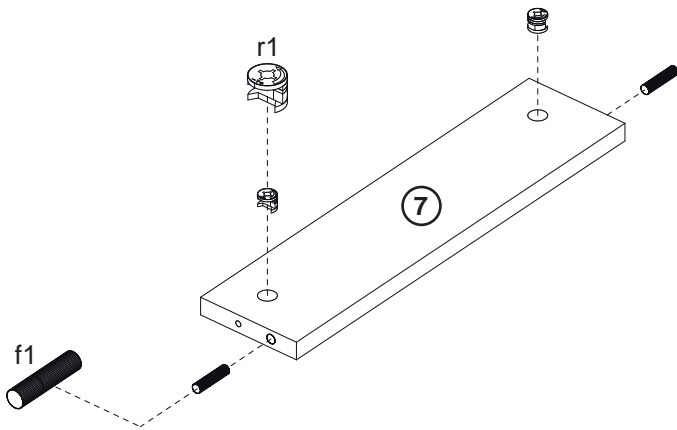
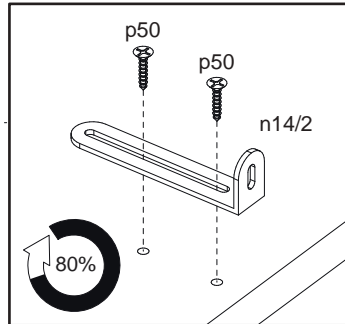
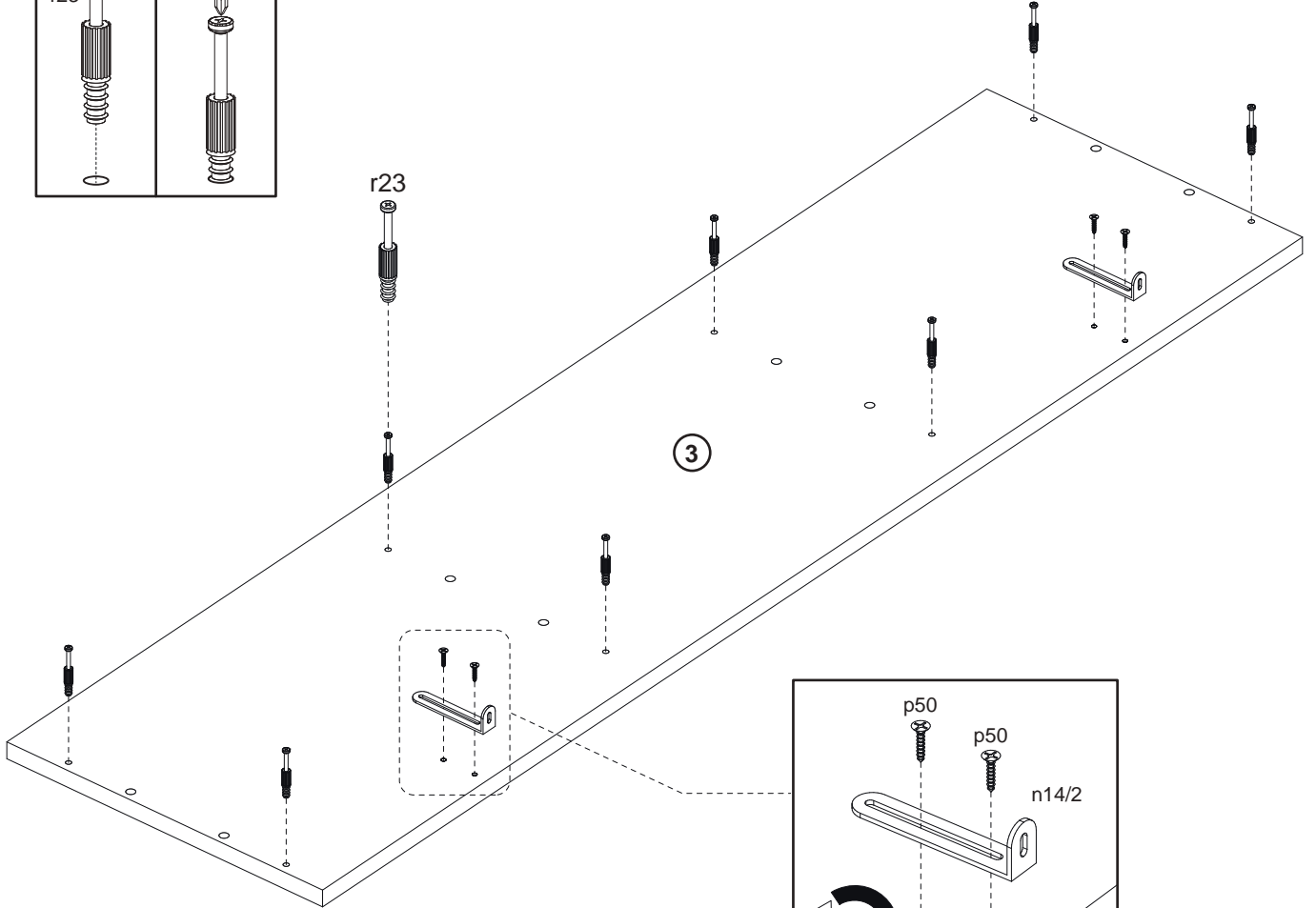
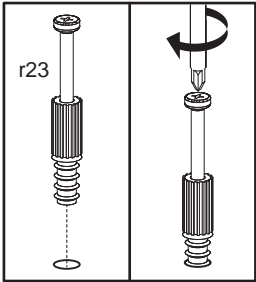

4

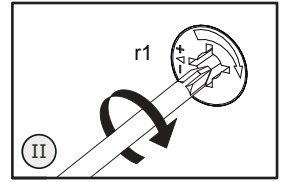
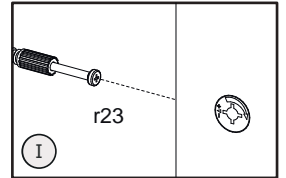
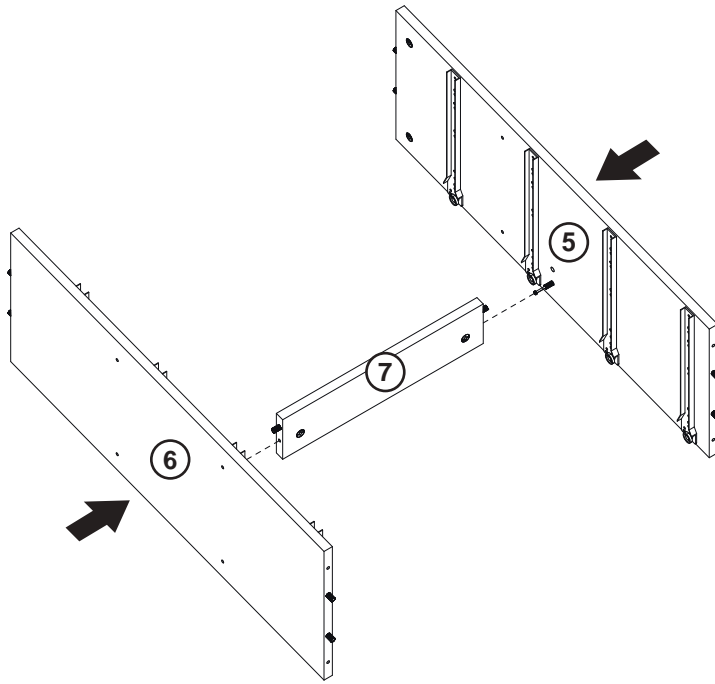

5

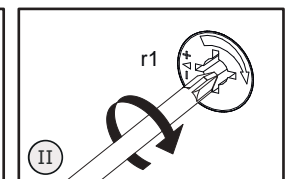
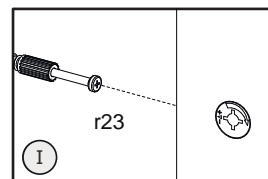
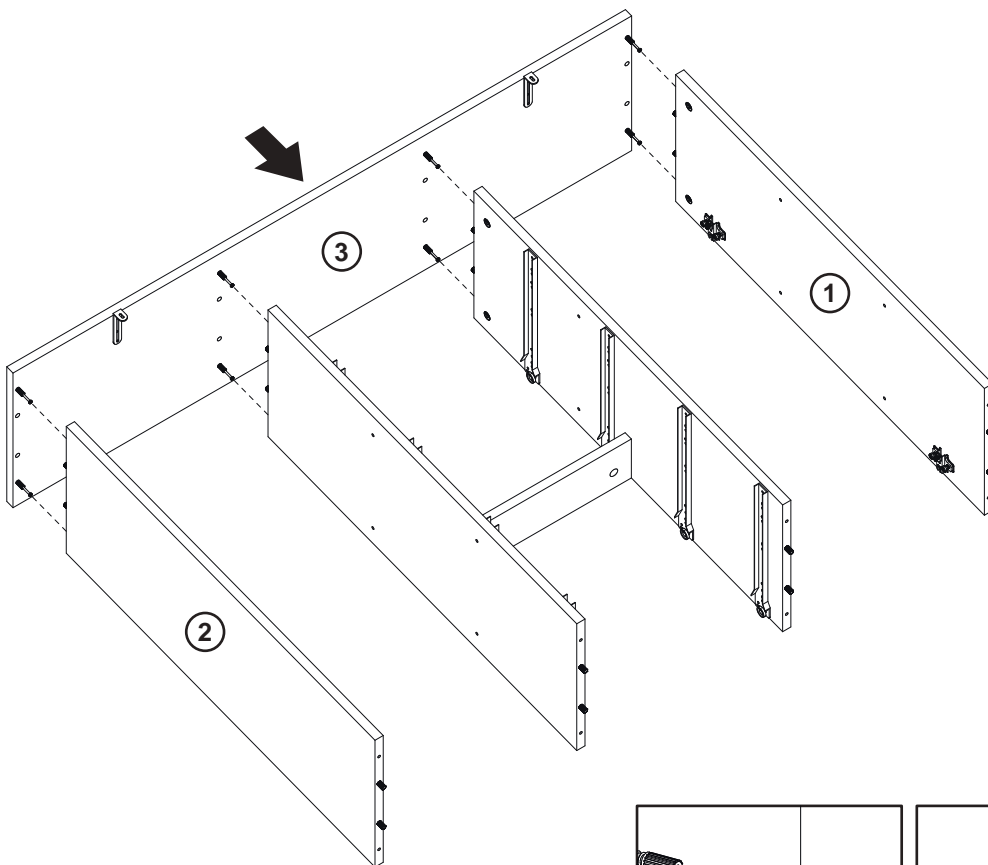

# 6

z1 x 1



4mm

e27 x 8



Ø 6,3x50mm

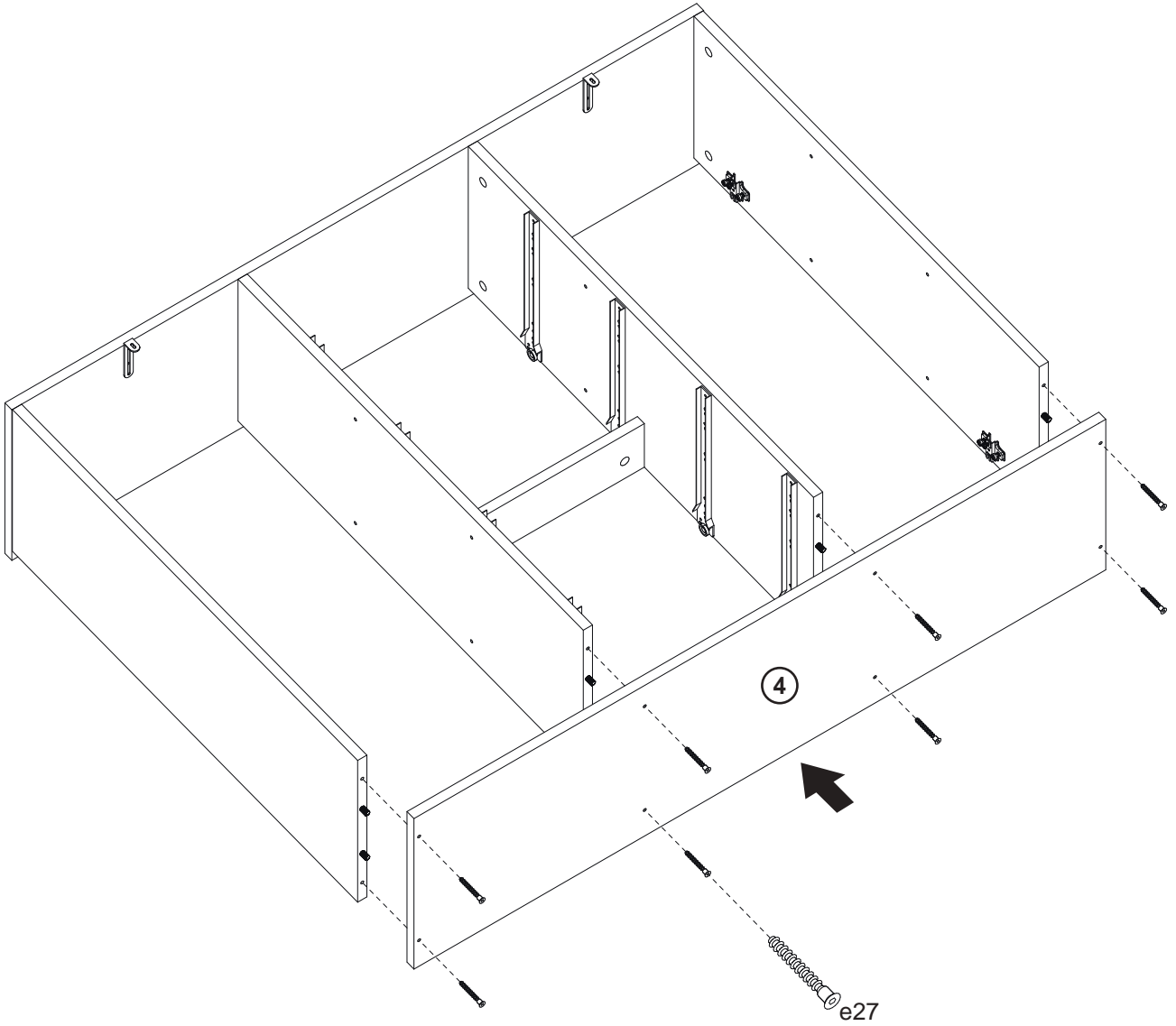
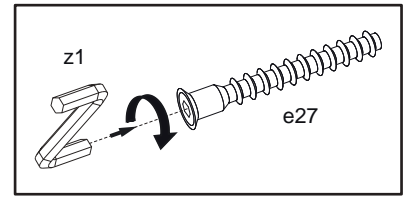
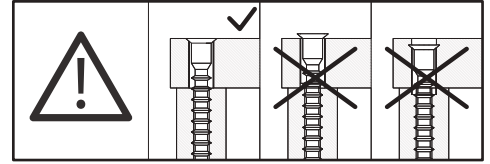



7

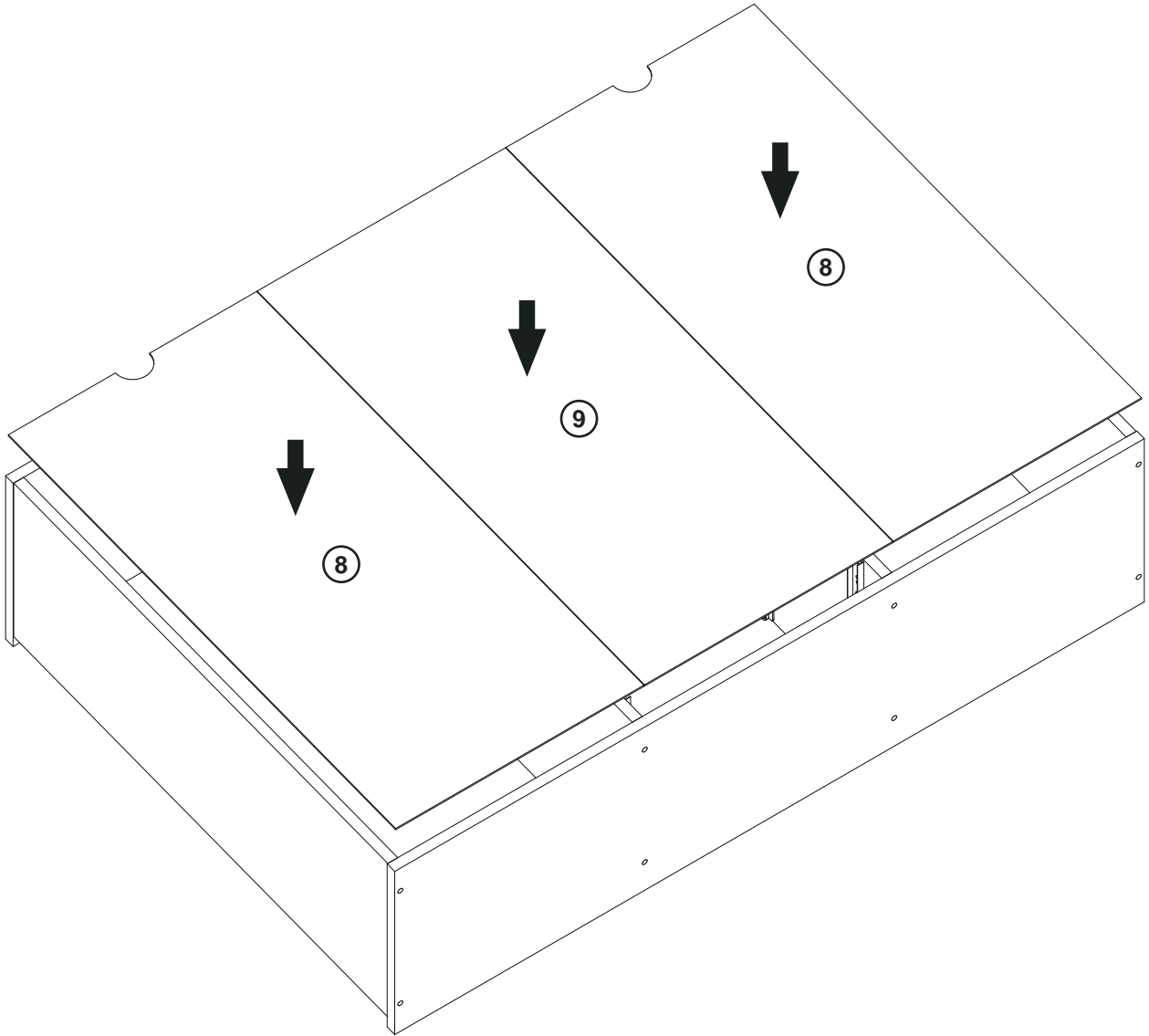

# 8

g1 x 40



Ø 2x20mm

n108 x 6

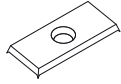

L=20x10x2mm

p50 x 6



Ø 3x16mm

k43 x 6



25x45x45mm

p23 x 6



Ø 4x25mm

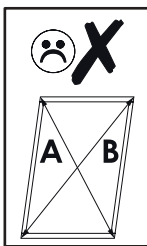
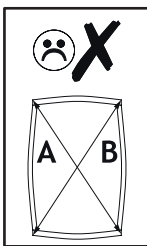
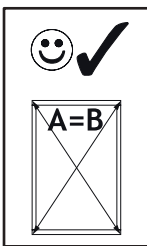
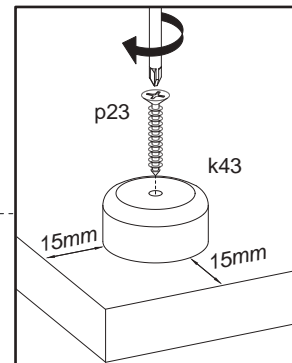
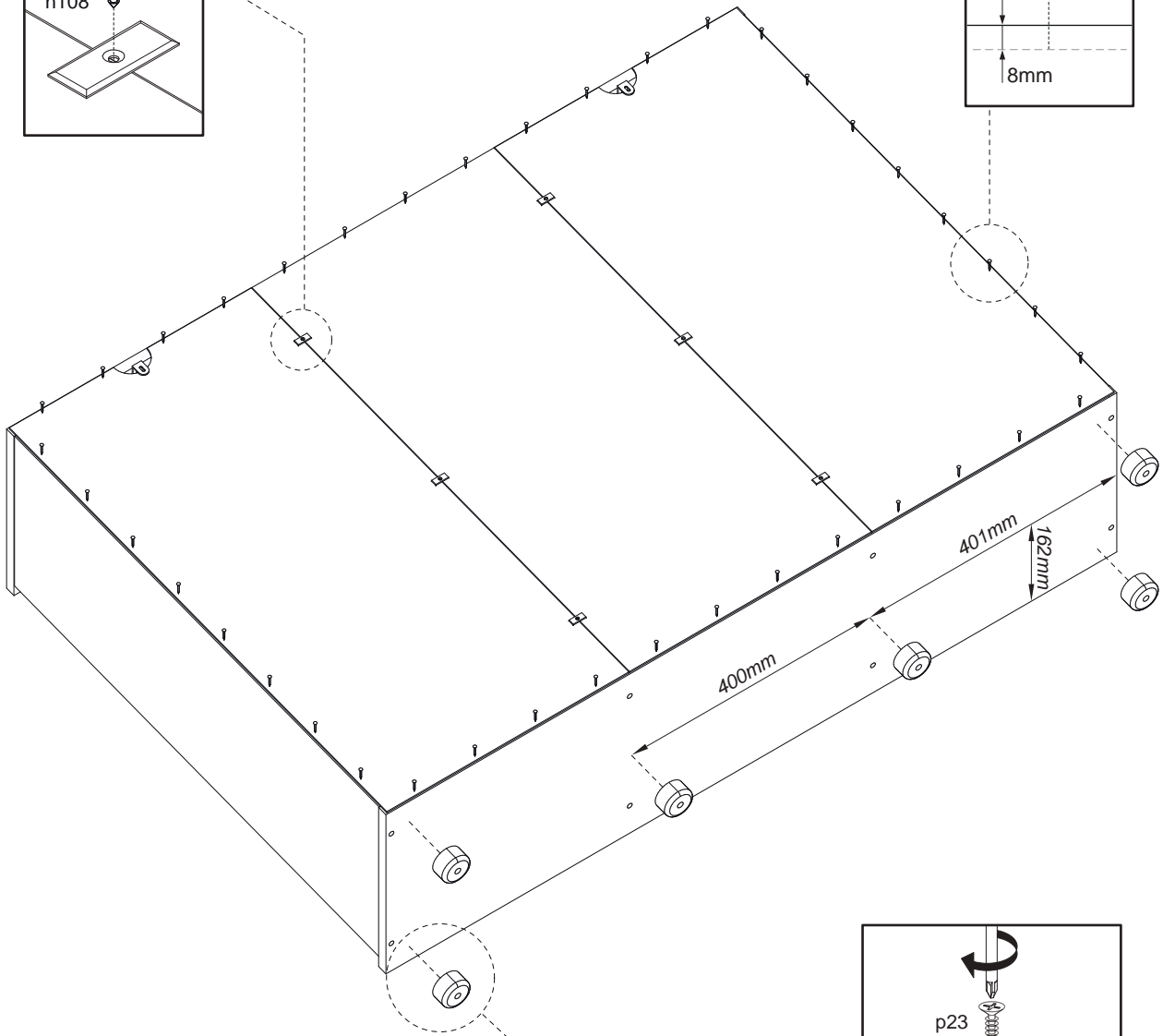
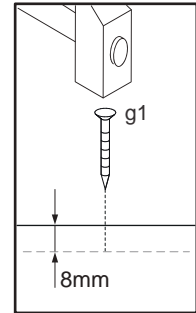
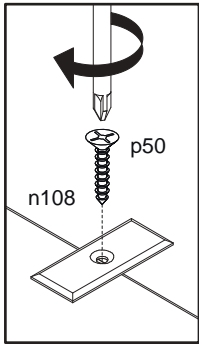

9

d1 x 16



Ø 5mm

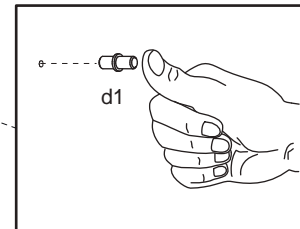
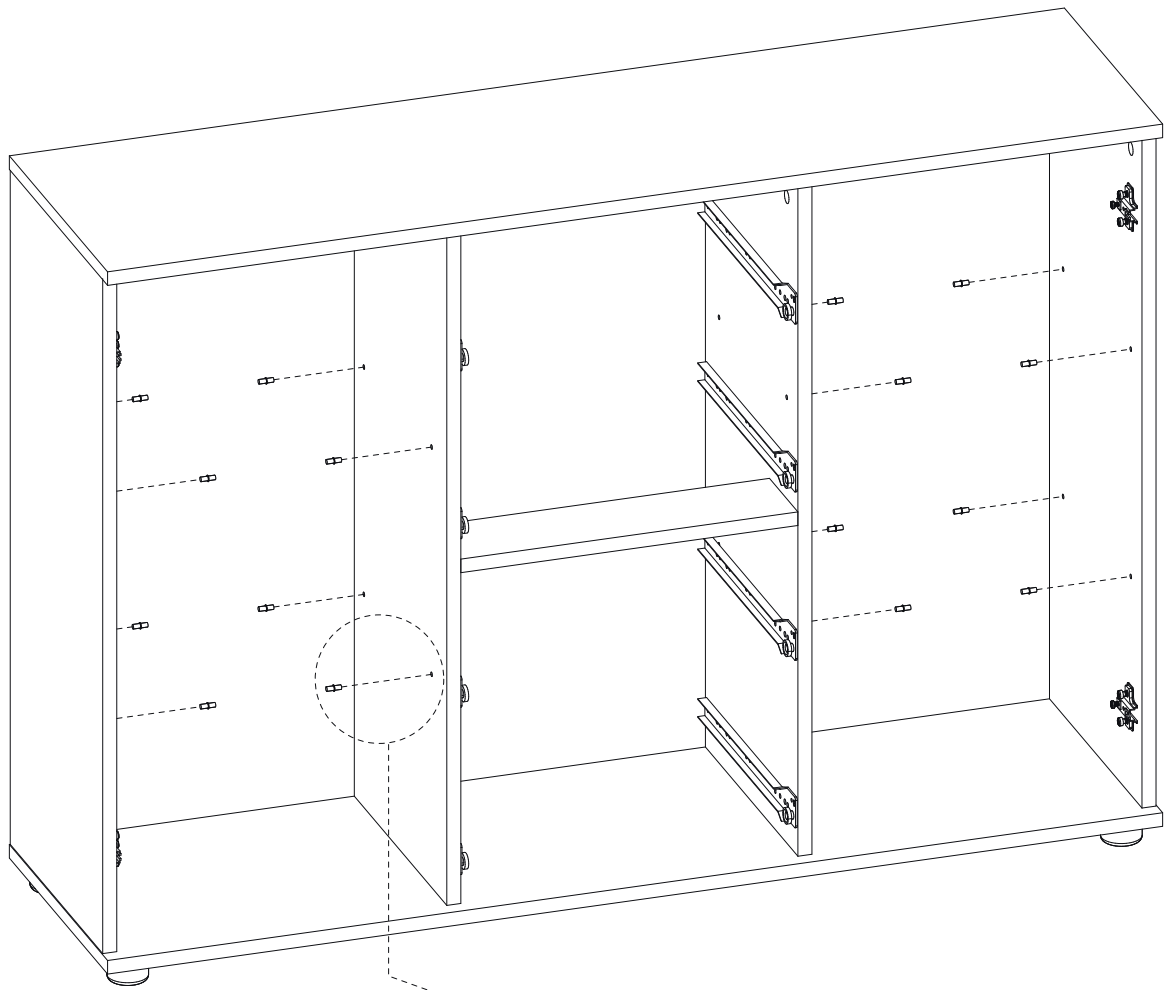

# 10

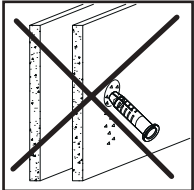
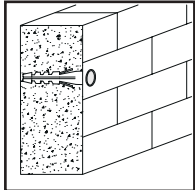
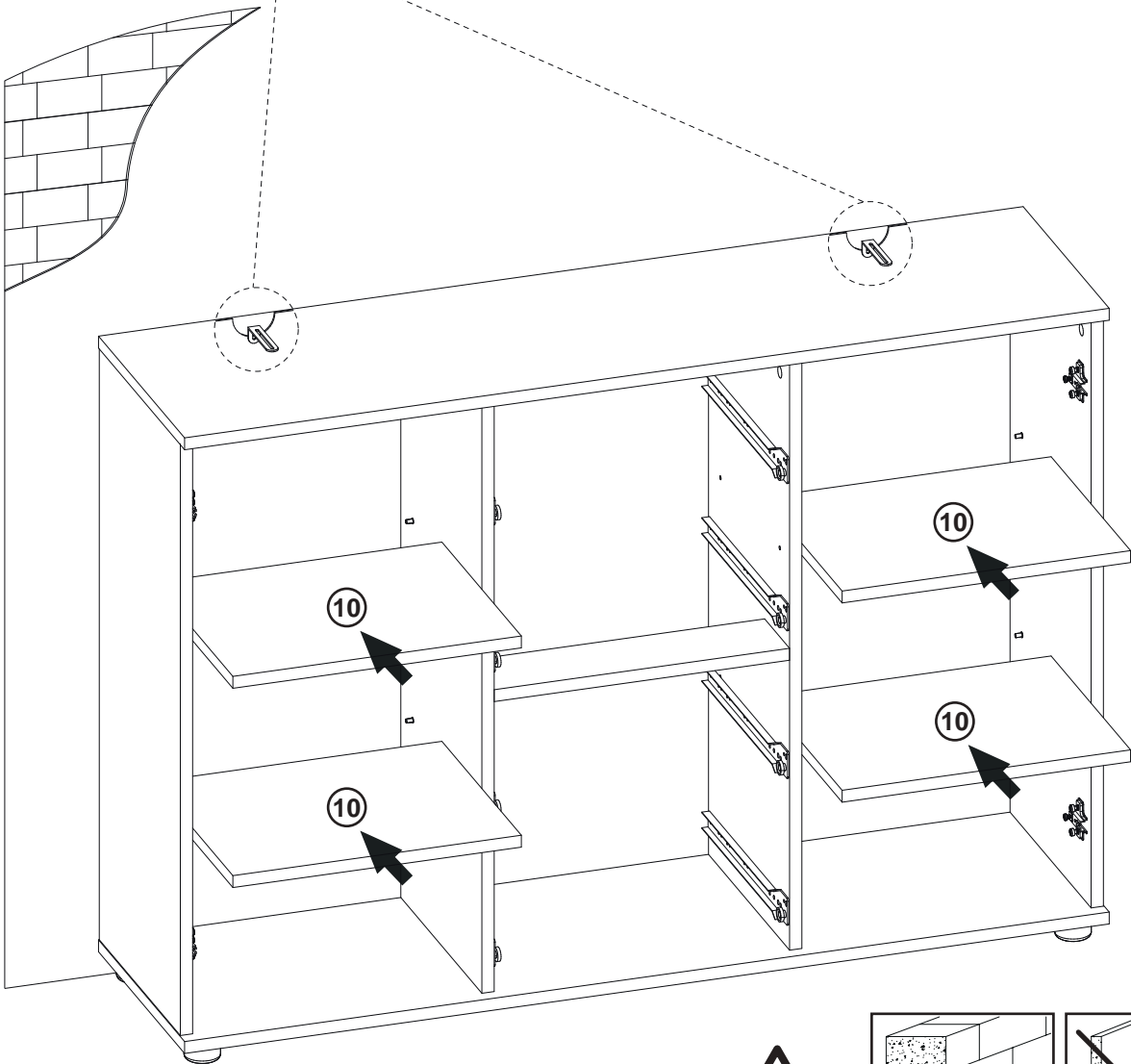
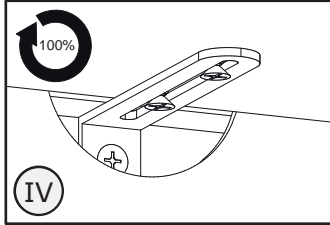
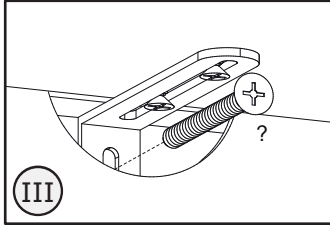
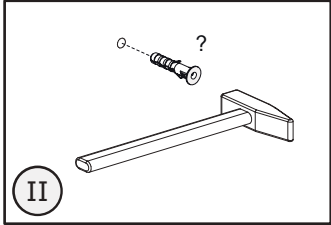
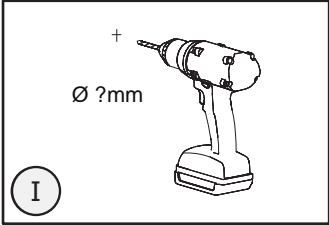
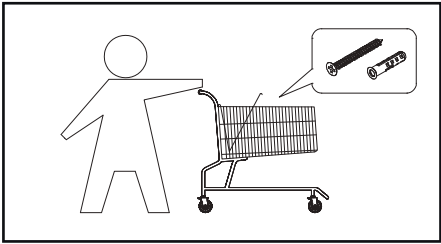

# 11

z1 x 1



4mm

e27 x 16



Ø 6,3x50mm

r1 x 8



Ø 15x12mm

r23 x 8

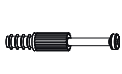

45mm

f1 x 16



Ø 8x30mm

s2 x 8

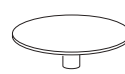

Ø 20mm

c242 x 4



L=128/148mm

p25 x 8



Ø 4,2x25mm

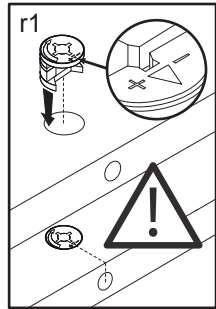
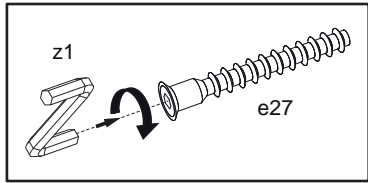

### A

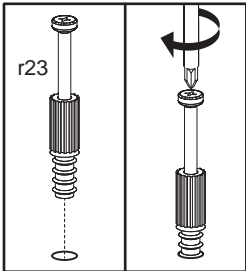
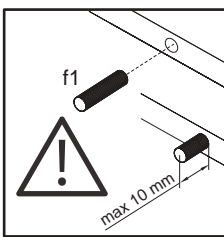
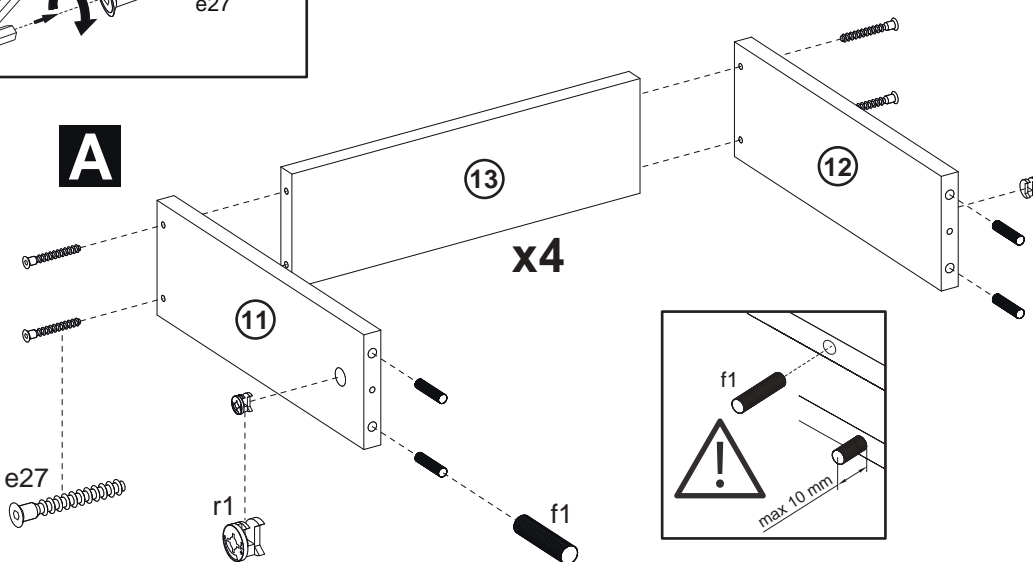

### B

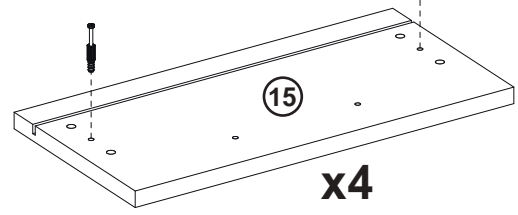

### C

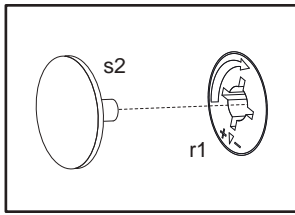
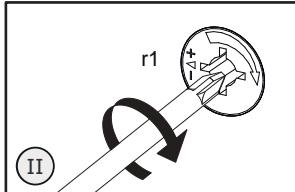
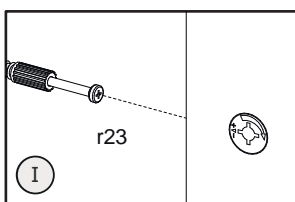
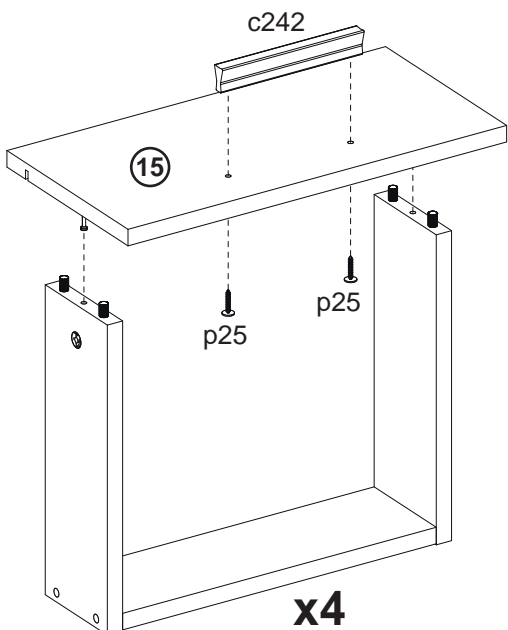

# 12

g1 x 16



Ø 2x20mm

n1/2 x 4

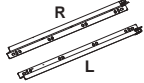

L=300mm

p50 x 16



Ø 3x16mm

## D

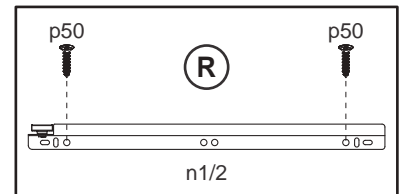
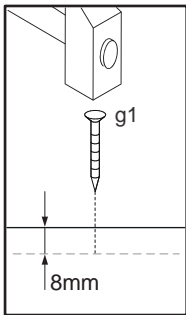
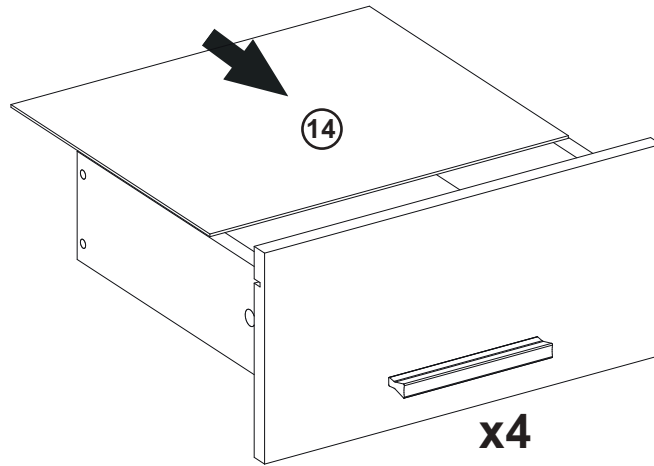

## E

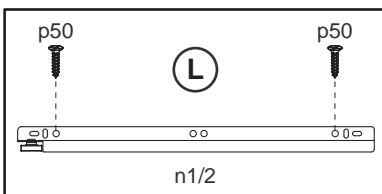
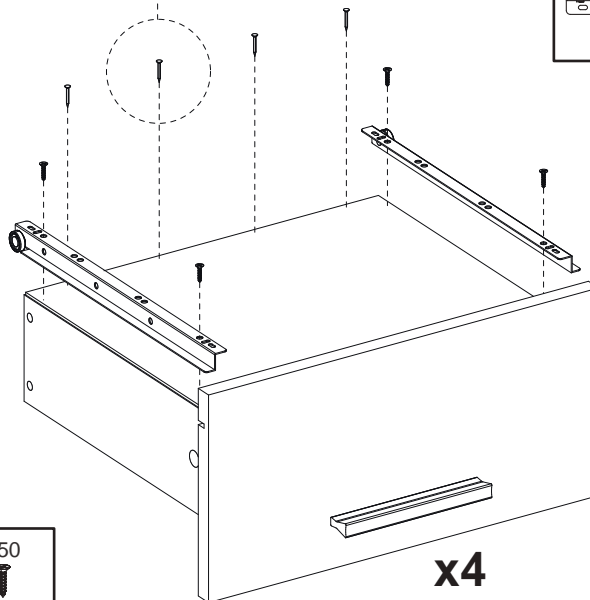

13

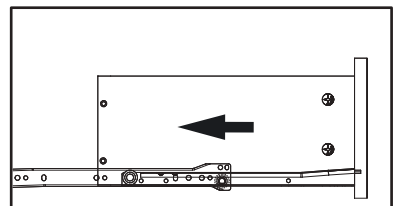
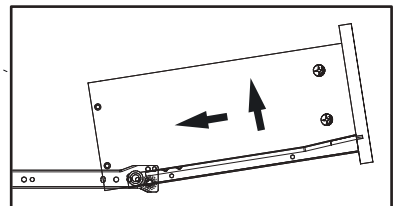
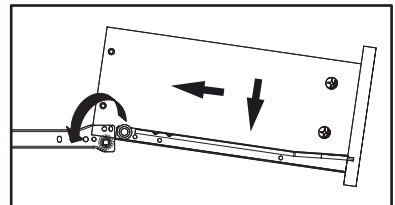
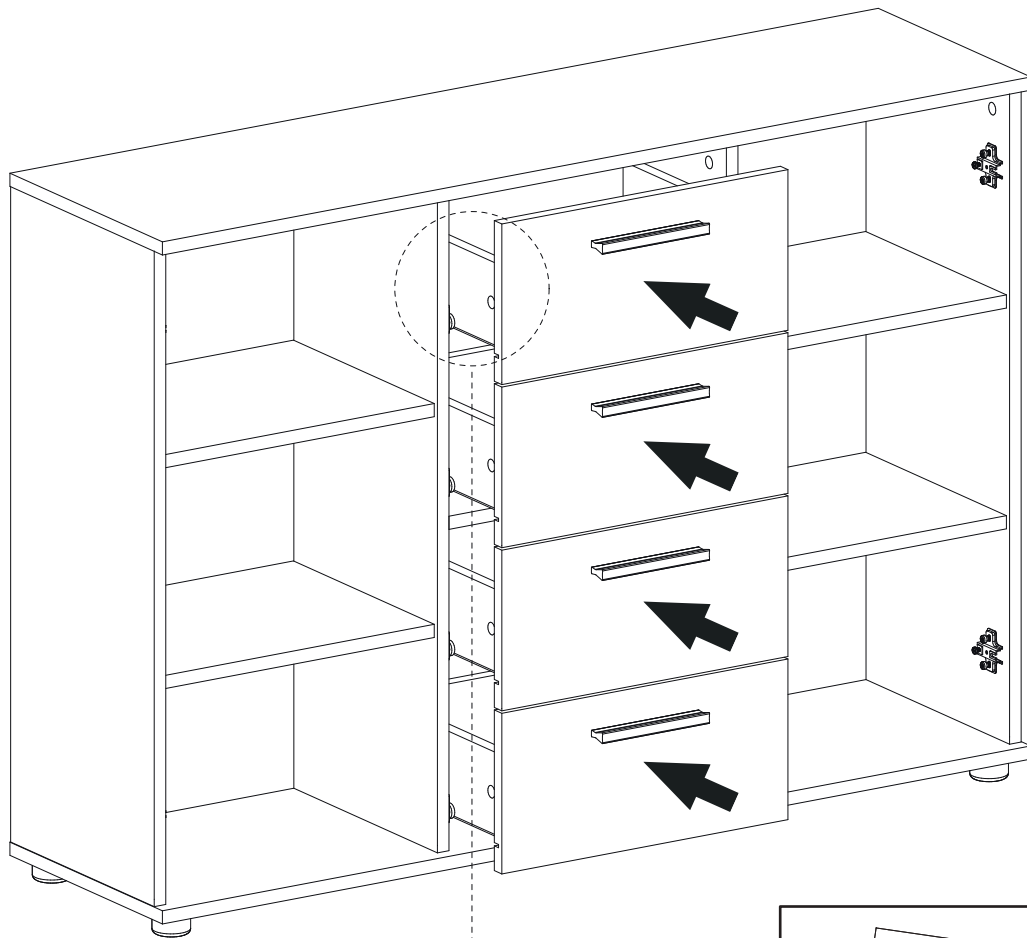

# 14

p51 x 8



Ø 3,5x16mm

a1 x 4

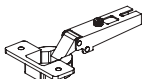

Ø 35mm

c242 x 2



L=128/148mm

p25 x 4



Ø 4,2x25mm

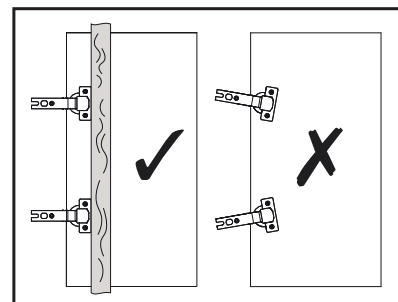
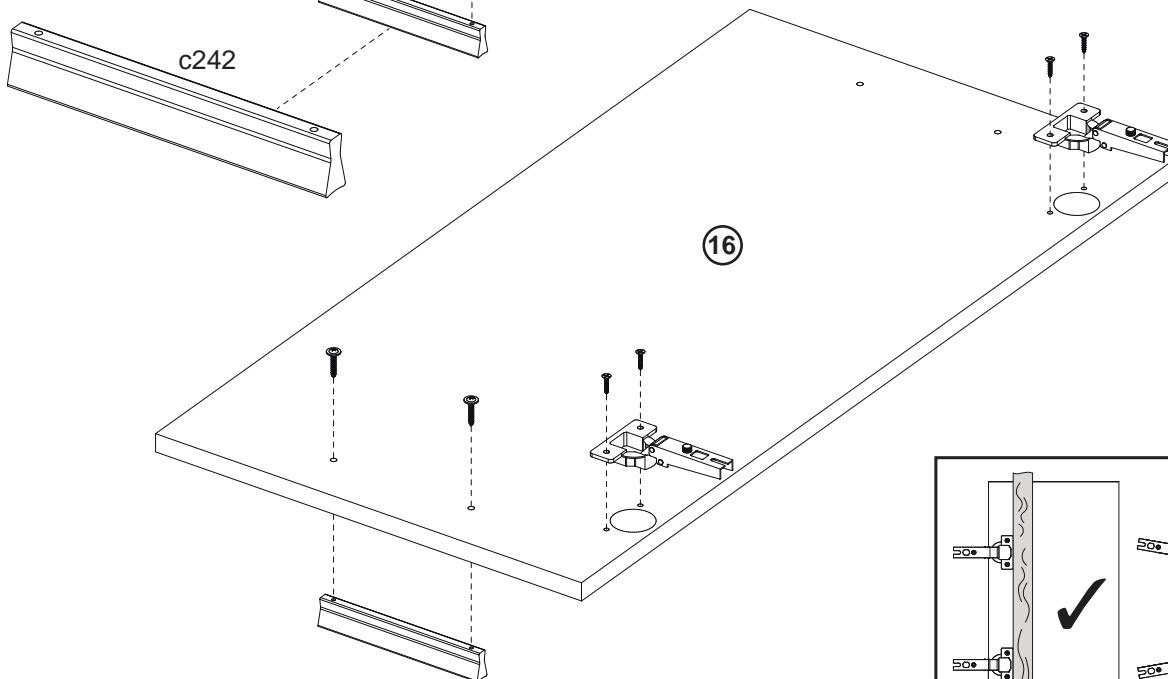
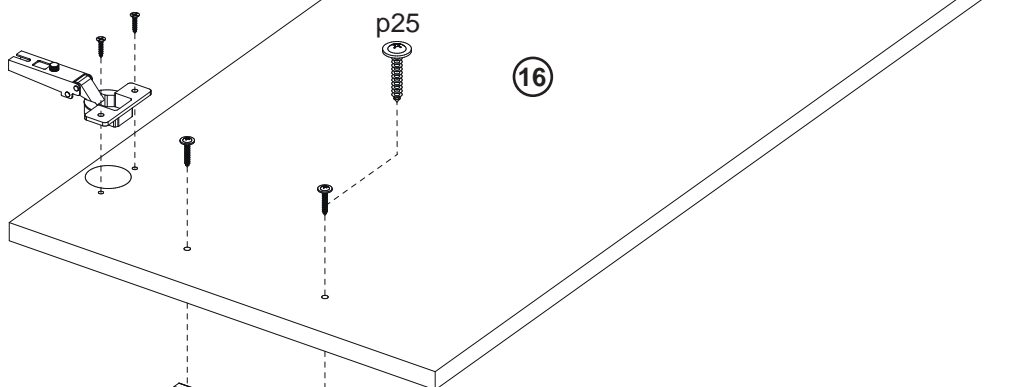
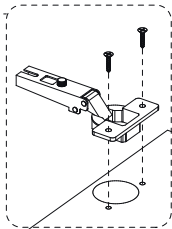
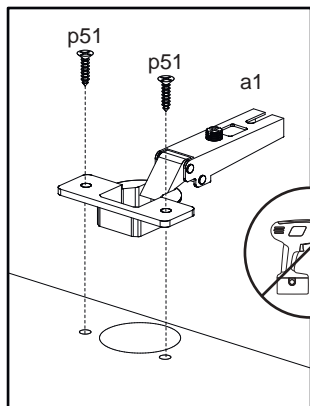



# 15

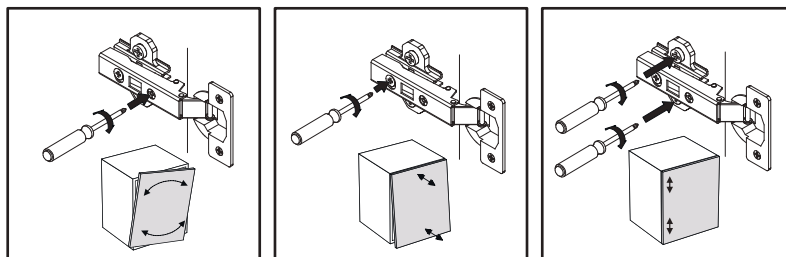
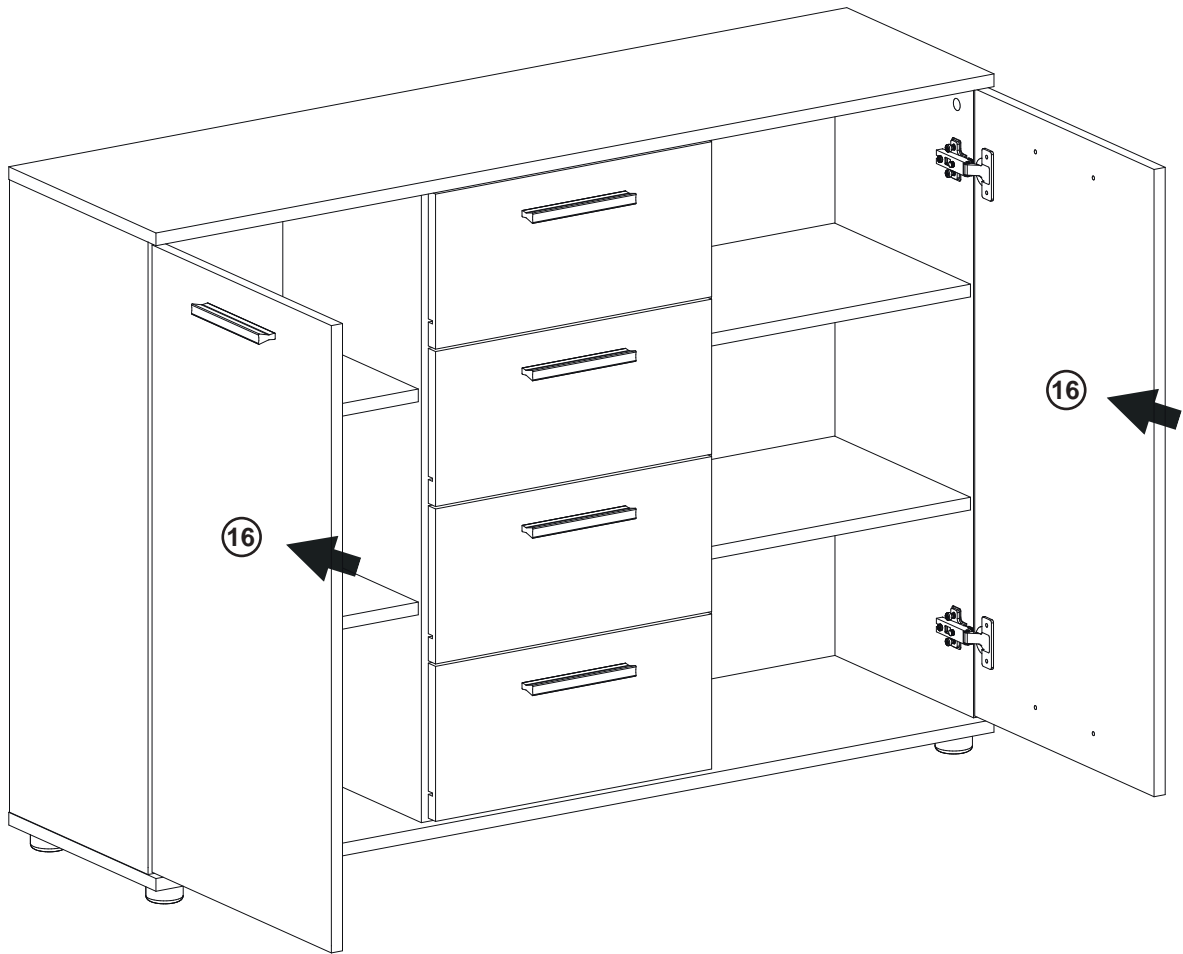
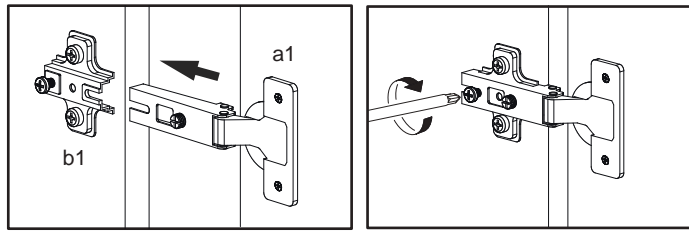

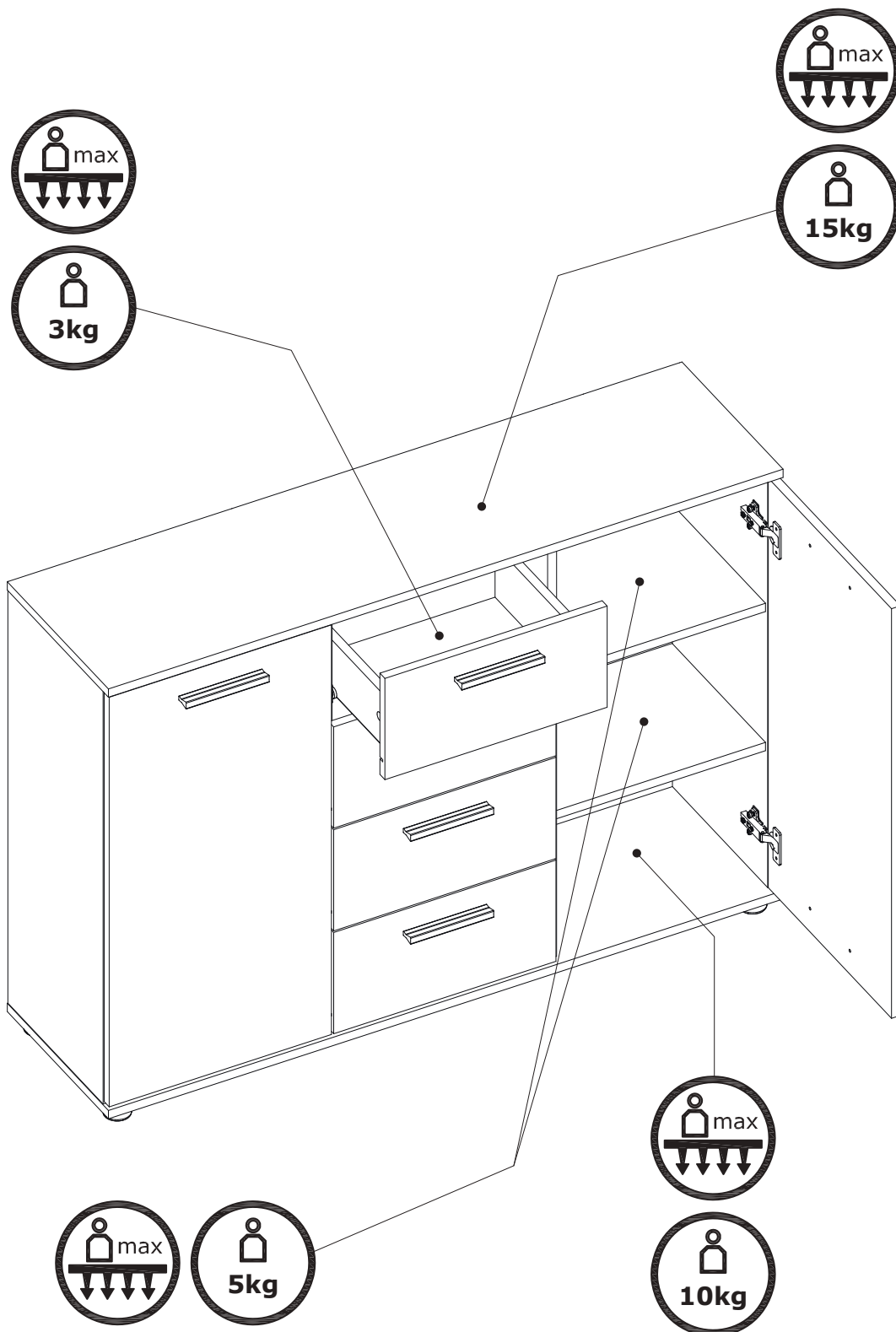

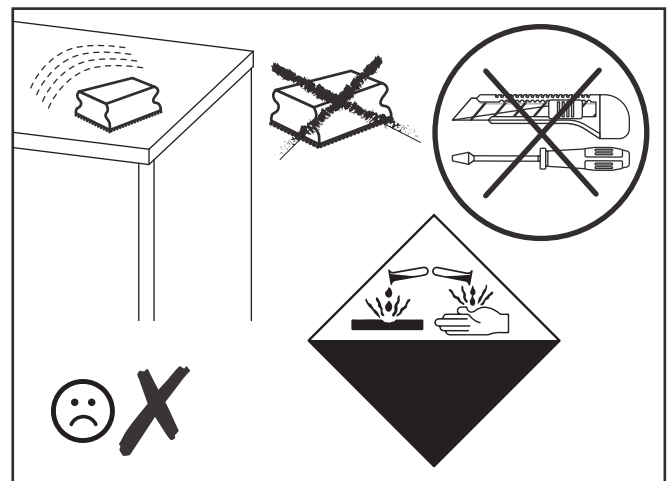
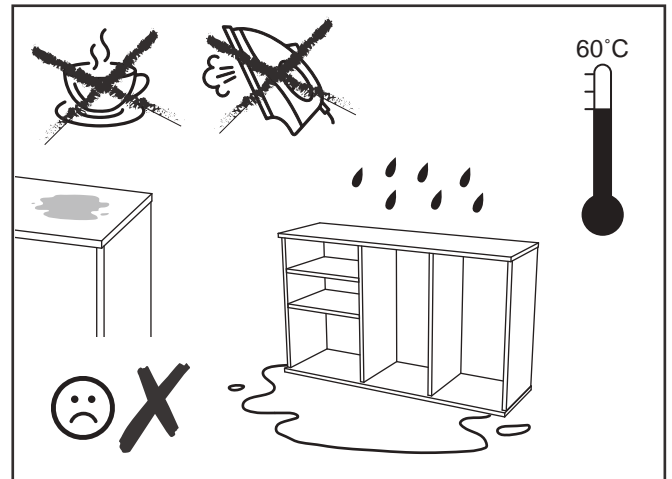
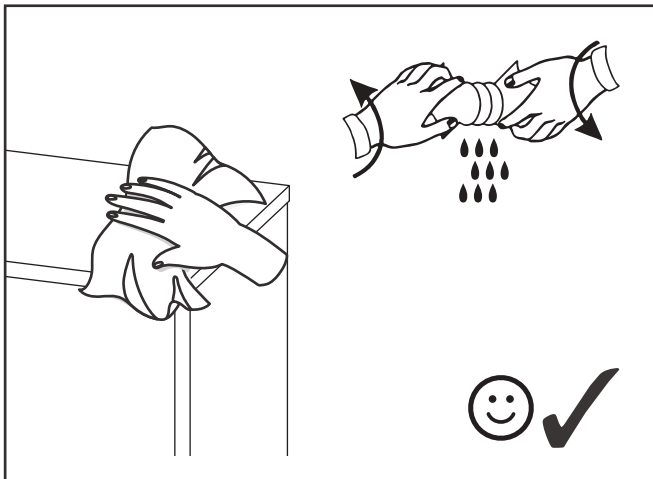
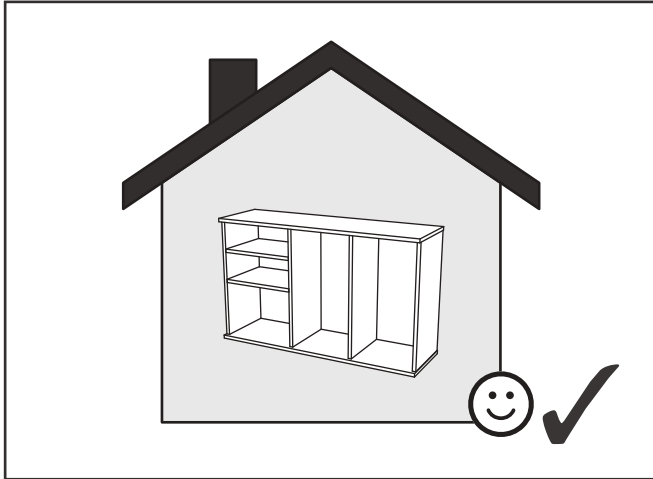

- PL** Powierzchnię mebli należy czyścić tylko środkami do pielęgnacji mebli. Szanowny kliencie w przypadku reklamacji prosimy wypełnić druki reklamacyjne dostępne w punktach sprzedaży przedkładając Kartę Reklamacyjną (zawierającą datę produkcji i numer pakowacza lub zmiany pakowania) umieszczoną w każdej z paczek, oraz instrukcję montażu mebla, gdzie prosimy o zaznaczenie uszkodzonego elementu.
- SK** Povrch nábytku čistite iba prostriedkami určenými na ošetrovanie nábytku.Vá ení zákazníci! V prípade reklamácie prosíme, aby ste vyplnili tlačivá, ktoré sú prístupné v obchodoch, predlo ili Reklamačný list (ktorý obsahuje dátum výroby a číslo baliča alebo číslo zmeny pri balení), ktorý sa nachádza v ka dom balení a návod na montá nábytku, v ktorom označte poškodenú čas.
- CZ** Povrch nábytku čistíte pouze přípravky určenými k ošetřování nábytku.Vá ený zákazník, v případě uplatnění reklamacce vyplňte prosím reklamační formuláře, které jsou dostupné v prodejnách a předlo te Reklamační kartu (obsahující datum výroby a číslo balení nebo změny balení, která je umístěna v balíčku) a návod k obsluze s vyznačením poškozeného dílu.
- BG** Повърхността на мебелите трябва да се почиства само с препарати за поддържане на мебелите.Уважаеми клиенти, в случай на рекламация моля попълнете формулярите за рекламация, които ще получите в търговските пунктове, като представите Картата за рекламация (съдържаща датата на производство и номера на опаковчика или смяната за опаковане), която ще намерите във всяка опаковка, и инструкцията за монтаж на мебела, върху която да отбележите повредения елемент.
- RO** Suprafata ei trebuie să fie curătată numai cu substanțe destinate pentru curățarea mobilei.Stimate Cumpărător, în caz de reclamație vă rugăm să completați formularul de reclamație pe care îl puteți lua de la punctul de vânzare și pe care îl veți prezenta împreună cu Cartela de Garanție ( care conține data producției și nr ambalatorului sau turei de ambalare), însoțită la fiecare ambalaj, precum și instrucțiunile de montaj ale mobilei, pe care vă rugăm să marcați elementul deteriorat.
- UA** Поверхню меблів потрібно чистити тільки засобами для догляду за меблями.Шановний клієнте для заяви рекламачії, просимо заповнити формуляр рекламачії, доступний у пунктах продажу, вказуючи рекламачійну карту (містить дату виробництва та номер пакувальника або зміни упаковки), прикладену до кожного пакету, а також інструкцію з монтажу меблів, на якій просимо позначити пошкоджений елемент.
- RUS** Поверхность мебели надо чистить только средствами для ухода за мебелью.Уважаемый клиент для заявления рекламации, просим заполнить формуляр рекламации, доступный в пунктах продажи, указывая Рекламационную карту (содержащую дату производства и номер упаковщика или смены упаковки), приложенную к каждому пакету, а также инструкцию по монтажу мебели, на которой просим обозначить поврежденный элемент.
- DE** Reinigen Sie den Möbelbereich nur mit Möbelpflege. Kunden, bei Beanstandung Bitte füllen Sie die Reklamationsformulare, die in den Verkaufsabteilungen erhältlich sind, vor dem Verkauf aus eine Reklamationskarte (mit Angabe des Produktionsdatums und der Anzahl der Personen, die die Waren verpacken, oder der Anzahl der Schichten)Verpackung), die in jeder Packung enthalten ist, und Halterungen, in denen Sie reichlich vorhanden oder beschädigt sind ElementeReinigen Sie den Möbelbereich nur mit Möbelpflege. Kunden, bei Beanstandung.
- GB** Furniture surface must be cleaned only with furniture maintenance formulas.Dear Customer, should you wish to file a complaint, we would request you to fill in the complaint forms available in our outlets, submitting the Complaint Card (specifying the date manufactured, packaging employee/ shift code) enclosed in each of the packets, together with the Assembly Manual, where please highlight the faulty component.
- H** A bútorok felületét kizárólag a bútorápolószerekkel lehet tisztítani. Tisztelt Vásárló! Reklamáció esetén kérjük az eladási helyeken kapható reklamációs nyomtatványokat kitölteni a Reklamációs Lap (tartalmazza a gyártási dátumát és csomagoló számát vagy műszakszámát) bemutatásával, amely mindegyik csomagban található, valamint a bútor szerelési utasítását, amelyen kérjük a sérült elemet bejelölni sziveskedjék.
- FR** La surface des meubles ne peut être nettoyée qu'avec des produits pour l'entretien de meubles. Cher Client, en cas de réclamation, veuillez bien remplir des formulaires de réclamation accessibles dans les centres de vente en montrant le mode d'emploi pour monter le meuble. Nous vous demandons de bien vouloir y entourer l'élément en panne.
- ES** Limpiar la superficie de muebles exclusivamente con los agentes para el cuidado de los muebles.Estimado Cliente, en caso de reclamaciones, hagan favor de rellenar los formularios de reclamación disponibles en los puntos de venta, presentando las instrucciones de montaje de mueble, donde es necesario indicar un elemento estropeado.
- NL** Het oppervlak van meubels hoeft alleen te worden gereinigd door middel van meubelverzorging Beste klant voor de verklaring!  
klacht, vul dan het klachtenformulier in dat beschikbaar is in de verkooppunten, met vermelding van: klachtenkaart (bevat de fabricagedatum en het nummer van de verpakker of verandering van verpakking), bevestigd aan elk pakket, evenals instructies voor het installeren van meubels, die we u vragen te markeren beschadigd item.
- IT** Pulire le superfici dei mobili solo con gli appositi detergenti. Gentile Cliente, se desidera presentare un reclamo, Le chiediamo di compilare i moduli di reclamo disponibili presso i nostri punti vendita, presentando la Scheda di reclamo (specificando la data di produzione, l'imballaggio della merce o il numero di strati di imballaggio) allegata a ciascuna confezione, insieme al manuale di montaggio, dove si prega di evidenziare l'articolo difettoso.